



Wheat Production Handbook



K-State Research & Extension
Manhattan, Kansas

Contents

Growth and Development	
<i>Gary M. Paulsen, Crop Research Physiologist, Agronomy</i>	2
Varieties	
<i>Rollin G. Sears, Wheat Breeder, Agronomy</i>	7
Planting Practices	
<i>James P. Shroyer, Extension Specialist, Crop Production</i> <i>Hans Kok, Extension Specialist, Soil and Water Conservation</i> <i>Curtis R. Thompson, Extension Specialist, Crops and Soils, Southwest</i>	9
Nutrient Management	
<i>David A. Whitney, Extension State Leader, Agronomy</i>	12
Weed Management	
<i>Dallas E. Peterson, Extension Agronomy, Weed Specialist</i>	15
Disease Management	
<i>Robert L. Bowden, Extension Specialist, Plant Pathology</i>	18
Insect Management	
<i>H. Leroy Brooks, Extension Specialist, Entomology</i>	25
Irrigation Management	
<i>Danny H. Rogers, Extension Irrigation Engineer, Biological and Agricultural Engineering</i>	29
Harvest Suggestions	
<i>Randal K. Taylor, Extension Specialist, Farm Power and Machinery, Biological and Agricultural Engineering</i> <i>Mark Schrock, Farm Power and Machinery Researcher, Biological and Agricultural Engineering</i>	31
Storage Management	
<i>Randall A. Higgins, Extension Specialist, Entomology</i> <i>Joseph P. Harner III, Extension Agricultural Engineer,</i> <i>Carl Reed, Extension Specialist, Grain Science and Industry</i> <i>George Lippert, Extension Specialist, Entomology, Southeast</i>	34
Profit Prospects	
<i>Larry N. Langemeier, Extension Agricultural Economist-Adm. K-MAR-105</i>	38

Brand names appearing in this publication are used for product identification. No endorsement is intended, nor is criticism of similar products not mentioned. Persons using such products assume responsibility for their use in accordance with current label directions of the manufacturer.

More information about wheat can be found on the Wheat Page on the worldwide web at: <http://www.ksu.edu/wheatpage/>

Growth and Development

The Turkey hard red winter wheat brought to Kansas by Mennonites in 1874 quickly became the most important crop in the state. Continued improvements by breeding and modern technology for production have kept Kansas the number one wheat state in the nation. Hard red winter wheat has stayed important for so long because its traits and pattern of growth and development are best suited of all crops to the weather, soils, and other conditions in the state. However, weather in Kansas is less than ideal for wheat and, more than any other factor, limits grain yields in the state. Wheat growers in Kansas are highly knowledgeable and the soils are generally excellent, but grain yields are only a fraction of the 100-plus bushels per acre averages in some countries. The weather also limits the production inputs — the seeding rate, fertilizer, and pesticides — that can be used economically for high Kansas wheat yields.

What are the plant traits that enabled Turkey wheat and its successors, our present varieties, to become so important in Kansas? No single trait has been identified, and a combination of many different characteristics seems to be involved. Winter wheat is a cool-season crop and grows best under moderate temperatures, but it is able to resist both cold and hot weather. This hardiness is essential for wheat to endure the freezing temperatures of winter, the late frosts of spring, the high temperatures of June, and the droughts that can occur anytime. Because of its winter growth habit, wheat is planted during fall, becomes well established before winter, and “greens up” and starts growing quickly when conditions are favorable in spring. Winter wheat not only resists freezing temperatures during winter, it needs the cold to joint and flower so it can set grain in spring. Flowering also requires the lengthening days of spring, so it doesn’t occur until May, when the dangers of late frosts are usually past. The root system of winter wheat extends farther than that of any other wheat class, enabling the plant to obtain moisture from deep in the soil profile in times of drought. These growth and development traits make wheat highly adaptable to Kansas conditions.

The planting date is only one of the many management practices that are determined by the growth and development patterns of wheat. The seeding rate, for instance, sets the number of plants per acre and, along with tillers per plant, kernels per tiller, and weight per kernel, determines the yield of grain. A change to any of these yield components, such as a reduction in the tillering capacity, would change the seeding rate that is needed for maximum production.

By knowing how a wheat plant grows and develops, an understanding of why it responds as it does to

management and the environment can be gained. This publication tells how the wheat plant grows and develops. It also discusses some of the critical factors in its development at different stages of growth.

Growth Stages from Germination through Maturation

The growth and development of winter wheat are divided into stages. Germination leads to seedlings, the first stage of plant growth, followed by tillering, overwintering, jointing, boot, heading, and flowering. Maturation, or development of the grain, is divided into milk, soft dough, hard dough, and physiological maturity, the stage when kernel weight is maximum. Ripening, the last stage, occurs as the grain loses moisture until it is ready to harvest.

Germination and Seedling Emergence

Quality seed is essential for establishing a productive stand. Seed should have at least 85 percent germination and 56 pounds per bushel test weight and should not be shriveled. Large seeds have little, if any, advantage over normal, plump seeds when both are planted at equal volume or weight.

A wheat seed begins germination by absorbing water and oxygen. Adequate soil moisture and temperature are needed for this to occur. Two parts of the wheat seed are of greatest importance in germination. The embryo, or “germ,” gives rise to the radicle, or the seedling root, and the scutellum, or the first leaf. The other important part of the seed is the endosperm, which contains food in the form of starch and protein for germination and emergence.

The coleoptile, or second leaf, penetrates the soil and results in emergence of the seedling, usually within 5 to 7 days after planting. If the seed is planted too deeply, beyond the elongation distance of the coleoptile, seedlings cannot emerge and a poor stand will occur. Semidwarf wheat varieties form short coleoptiles as well as short plants, and planting depth is particularly critical for them.

A firm seedbed assures good contact between the seed and the soil. Inadequate soil moisture is probably the major reason for planting seed deeply. If the soil moisture runs out before the seedlings emerge, as can happen after light rains, survival of the seedlings often depends more on the stage of germination than the length of the dry period. Seedlings from seeds that have germinated for only one or two days can survive desiccation and resume growth when moisture reoccurs, but seedlings that are 4 or 5 days old probably will not tolerate drying.

The first roots on the wheat seedling are known as primary or seminal roots and include the radicle previously mentioned. Primary roots are usually temporary in wheat, unless the other roots fail to develop because of poor conditions. Only the main stem of a wheat plant has primary roots, which may be retained throughout the life of the plant. Most of the root system throughout the life of a wheat plant consists of secondary or crown roots that arise from underground nodes after the seedling emerges. Many of the roots on the main stem and all the roots on the tillers are secondary roots. The functions of roots are to anchor the plant and absorb water and mineral nutrients. Most of the roots are in the plow layer, or top 6 inches of soil, but some penetrate as far as 7 feet into the soil. Water and minerals actually are absorbed through fine hairs on the roots' surfaces. Extensive distribution of roots through the soil and the large surface area of the root hairs make the wheat plant efficient and drought-resistant.

The Growing Point and Seedling Growth

All above-ground growth on a wheat plant comes from a meristem termed the growing point. The growing point contains the stem parts—nodes and internodes—and the wheat head in miniature. It is protected by its underground location until spring, when it “differentiates” and the plant begins to joint and eventually heads.

The third seedling leaf is the first foliage leaf. It and the other foliage leaves — as many as five to seven in spring wheat and 11 to 15 in winter wheat — are the site of photosynthesis. Photosynthesis is the process in which small bodies called chloroplasts in cells of wheat leaves produce food and energy from sunlight, water, and carbon dioxide. All the foliage and grain produced by the wheat plant comes from photosynthesis.

Tillers are shoots that develop from nodal buds on older wheat shoots. The number of tillers is determined by the seeding rate, soil moisture and fertility, temperature, and variety. A winter wheat plant grown under usual conditions will have three to six tillers. Tillers develop soon after the seedling emerges from the soil and have all the other growth stages of the main stem.

Tillering can be encouraged by planting early; fertilizing with nitrogen; and, where possible, irrigating if soil moisture is low. Late planting is particularly disadvantageous because it reduces tillering and must be compensated by higher seeding rates. Tillers are formed only during the fall but make most of their growth in the following spring.

Overwintering

Decreasing daylength and gradually falling temperatures during fall prompt the wheat plant to develop a high level of cold hardiness. Most varieties

also undergo a change from an upright to a prostrate growth form. Hardiness usually is greatest during early winter and is lost gradually as the season progresses. Most winterkilling occurs during late winter, when warm spells cause the plants to lose hardiness and then are followed by cold fronts that cause the damage. Snow provides excellent protection because it insulates the plants from extreme cold and keeps them from responding to warm spells. The critical plant part is the growing point, which is protected partially by being about 1 inch below the soil surface during winter. The entire plant is killed by injury to the growing point, which turns from a white, turgid appearance to a brown, wilted appearance after it is frozen. Leaves often stay green during mild winters, but freezing or “burning” of leaves by cold has little effect on yield.

Tillering

Warming temperatures in late winter cause wheat to “green up” and resume growth. Tillers that were initiated in the previous fall grow rapidly and change back from the prostrate form to an upright form as the sheaths, the parts of the leaves that cover the stems, become longer. Nitrogen fertilizer should be top-dressed at this time to stimulate growth of the tillers, which will produce most of the grain at harvest. The growing points are still at their protected underground position at this stage, but drought and other stresses may restrict growth of the tillers. Herbicides such as 2,4-D stop development of the tillers and should not be applied at this stage.





Jointing and Boot

Jointing, the development of nodes and internodes that form the stem of the wheat plant, begins when growth of the tillers is complete. This phase marks the change from vegetative growth to reproductive growth and is important for several reasons. Growth of the internodes pushes the growing point above the soil, and grazing must be halted so that it is not removed by livestock. The elevated position of the growing point along with the gradual loss of winterhardiness also makes the plants increasingly susceptible to late frosts. The growing point is the most susceptible of all plant parts to frost at this stage. New tillers might replace tillers in which the growing point has been damaged by frost, but the yield usually is reduced substantially. The change from vegetative to reproductive growth also is when the maximum number of kernels that will be formed in the head (spike) is determined, causing the yield at harvest to be susceptible to stress at this stage.

Jointing does not occur until the plants have been exposed to winter temperatures and begin spring growth. Exposure to low winter temperatures is necessary to induce jointing in winter wheat; without it, the plants would continue to produce more leaves.

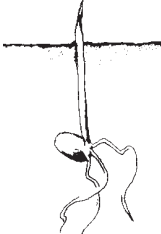
Continued on page 6

WHEAT PRODUCTION CALENDAR

	July	August	September	October	November	December
Wheat Growth Stage			Stage 1 one shoot 	Stage 2 tillering begins 	Stage 3 tillering continues 	Stage 3 winter dormancy prostrate growth 
Production Practice	Prepare Seedbed & Control Volunteer Wheat			Select Varieties		Livestock
	Soil Test—Apply Preplant Fertilizer					
	Clean and	Optimum Planting				
Insect and disease management	Treat Seed		False Wireworms			
			Grasshoppers			
			Flea Beetles			
					Greenbugs	
			Hessian Fly			
Weed Management	Control Weeds				Control Broadleaf Weeds	
	Manage Perennial Weeds				Control Winter Annual Grasses	
Stored grain Management						Inspect Monthly
	Danger—Insect Reproduction					
	Aerate to Remove Field Heat		Aerate to Reduce Grain Temperature to 45°F			

WHEAT PRODUCTION CALENDAR

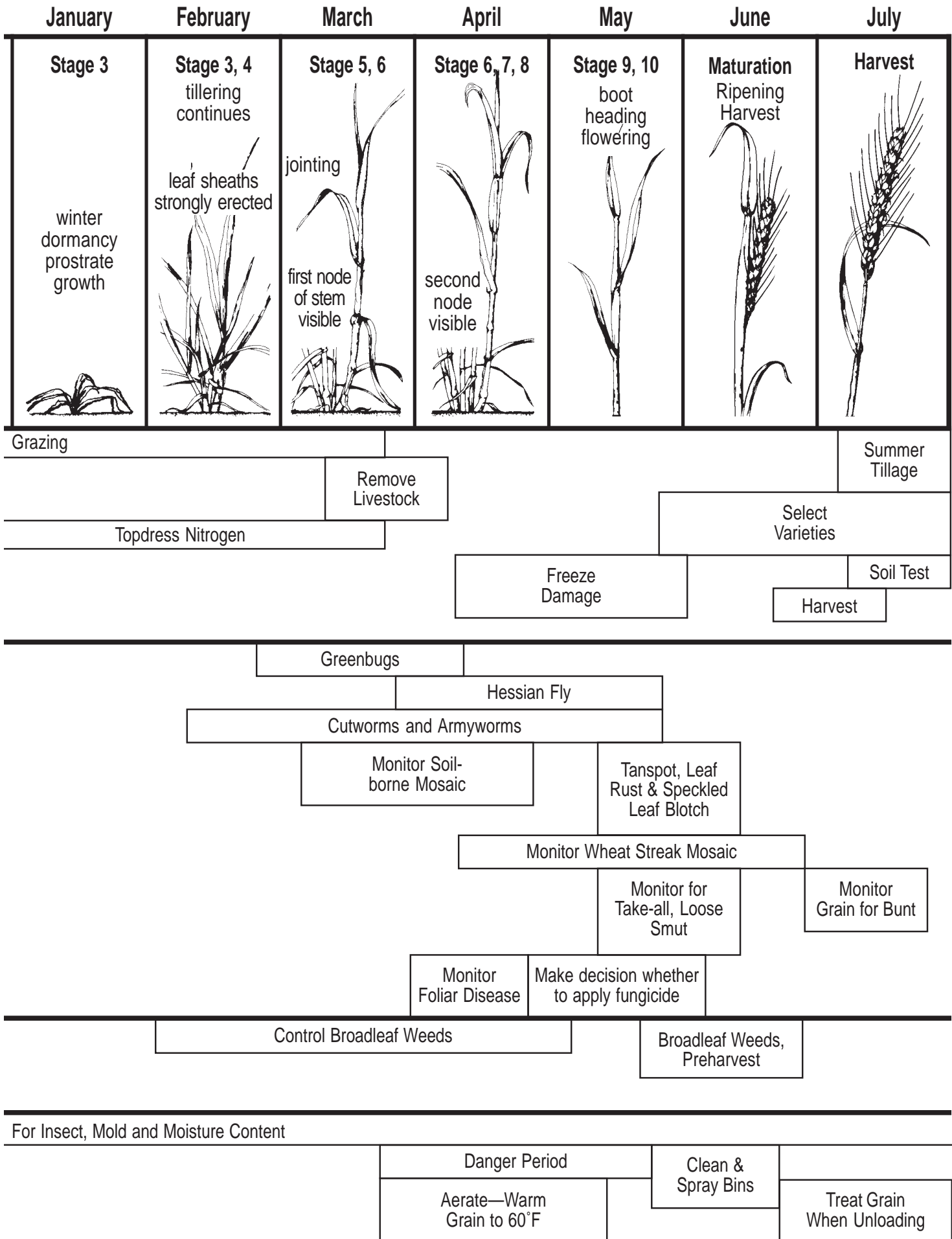

Splitting open the wheat stem during jointing shows the growing point is well differentiated into the young head. During the boot stage, the head is enclosed in the flag leaf sheath at the top of the plant.

Heading and Flowering

At the heading stage, the spike emerges from the boot. Within 1 to 7 days after heading, the flowering stage and pollination occur, and the grain begins filling. Most plants, including wheat, have very specific day-length requirements for flowering. Wheat is classified as a long-day plant because it will flower only when days are long and nights, the important times, are short.

Flowering usually begins in the center of the spike and progresses toward the ends and occurs 1 or 2 days earlier on the main stem than on the tillers. Appearance of the yellow anthers outside of the florets marks the completion of flowering. The actual number of kernels that will form in the spike is determined at this stage. Wheat is highly self-pollinated and quite resistant to most stresses except frost during flowering. Temperatures only slightly below freezing quickly kill the male flower parts, sterilizing the florets so no grain is formed. However, only part of the spike might be sterilized because of the variation in flowering, so grain might form on the center or ends but not on the other parts.

Maturation and Ripening

The grain begins growing immediately after flowering and reaches its maximum size (not weight) within about 2 weeks. The maximum weight occurs about 4 weeks after flowering in Kansas. This period is determined largely by temperature and can extend up to 12 weeks in areas where the weather is cool.

Grain development stages are determined by the hardness or consistency of the endosperm of the new kernel. At the first stage, the endosperm has the color and consistency of milk. As the kernel fills, the endosperm thickens into a soft dough stage and finally a hard dough stage. The doughy property of Kansas winter wheat can be observed easily by chewing the kernel. Physiological maturity occurs when the kernel has accumulated its highest content of dry matter, has hardened, and changed color. The kernel contains 30 to 35 percent water at physiological maturity.

Protein and starch are the most important constituents of the wheat kernel. Most of the protein comes from nitrogen previously accumulated in the leaves, and most of the starch is from sugars made by photosynthesis during the grain-filling period. The nitrogen moves into the filling kernels to form protein during early grain development. This is why, if yields are low because the kernels do not fill properly, the grain is high in protein. Drought and high temperatures are

usually responsible for this condition. If the grain fills normally and yields and test weights are high, grain protein is frequently lower because it is diluted by other materials. Of course, under good growing conditions, grain protein can be increased with nitrogen fertilizer.

Most of the leaves senesce, or die, soon after flowering, but the flag leaf, glumes, and awns remain active during most of the grain-filling period. Photosynthesis in the awns, or beard, provides 10 to 20 percent of the grain weight. This is why nearly all the wheat varieties grown in Kansas have awns. In cooler areas with higher rainfall, wheat leaves remain active longer, and awns are less important.

The final yield component, kernel weight, is determined during maturation. Yields are high when favorable filling conditions, mild temperatures, and active leaves promote growth of large, plump kernels. High temperatures, especially when accompanied by winds, and foliar diseases such as leaf rust cause shriveled kernels, low test weights, and low yields.

Ripening includes the changes that occur after the grain reaches physiological maturity. The most important change is the loss of moisture from 30 to 35 percent in mature grain to 12 to 13 percent in combine-ripe grain.

Grain must be harvested promptly after ripening to save the yield. Hail, lodging, and preharvest sprouting are ever-present threats to ripe grain.

Growth Stages and Management

Nitrogen fertilizer, pesticides, and irrigation must be applied to wheat at certain times to have the most effect. Proper timing for most operations is determined by the growth stage, not by the calendar date. Because growth at any given date can vary from one year to the next, it is important to be able to recognize the different growth stages of wheat.

Two systems, the Feekes' and the Zadoks' scales, are used for growth stages of wheat. The Feekes' scale goes from 1 for the first seedling leaf through 11.4 for mature plants with hard grain. The Zadoks' scale starts with 01 for seed germination and goes to 92 for hard grain and 99 for loss of dormancy by this grain. The wheat production calendar on pages 4 and 5 gives the Feekes' scale for wheat growth stages, the dates when they usually occur in Kansas, and important management operations that should be done at each stage.

When Wheat Does Not Grow

A wheat plant is exposed to many hazards during its lifetime. Low temperatures, high temperatures, drought, hail, and wind will be mentioned here. Damage from these occurs in adverse environments such as Kansas. Losses can be decreased by developing more adaptable varieties and using proper management but can never be eliminated entirely.

Low temperatures injure wheat by winterkilling, by early spring freezes that kill the growing point, and by late spring freezes that cause sterility of the heads. Winterkilling can be caused by direct freezing, ice sheets, and desiccation. Hardier wheat varieties and possibly milder winters have made winterkilling less of a problem than it used to be. Improved management also has helped. Timely seeding, good seedbed preparation, and careful fall pasturing to leave plants vigorous and capable of holding snow during low temperatures are good management practices. Spring freezes seem to have become important in recent years. Newer wheat varieties that mature earlier, initiate spring growth earlier. When spring growth starts, winter wheat rapidly loses hardiness and is damaged easily by low temperatures.

High-temperature damage is most apparent during grain filling when the kernels are shriveled and prematurely ripe. It also can occur during fall and cause poor tillering and hardening. During winter, high temperatures can stimulate wheat to grow so that it will be injured by subsequent low temperatures. Early-maturing varieties have decreased high-temperature losses. Because high-temperature stress and moisture stress usually occur together, irrigation and moisture-conserving practices can decrease losses.

The wheat plant combines drought escape and drought resistance to overcome moisture stress. Most of its growth occurs during fall and early spring, which are periods of highest rainfall. Wheat is harvested before the dry summer months and, in that way, escapes drought. Nevertheless, low moisture and high temperature are considered limiting factors for wheat production in Kansas.

Its extensive root system enables the wheat plant to obtain moisture from deep in the soil. In low-rainfall

areas, soil moisture is depleted by continuous cropping but is replenished by fallowing. The wheat plant also adjusts to low-moisture conditions by forming fewer tillers; producing less foliage; and decreasing transpiration, the loss of water from the leaves.

Extent of hail damage to wheat depends on the severity of the hail, the growth stage when it occurs, and the variety. Hail before the boot stage injures wheat in proportion to the amount of foliage removed. Wheat is most susceptible to hail damage from the boot stage through the milk stage. Florets on the wheat head in the boot are injured easily by hail. Injury during early grain development stages causes the grain to stop filling. At later stages of grain development, hail shatters the kernels from the head. Stems injured by hail often are broken over or off by winds or further damaged by diseases.

Wind injury to wheat usually is caused by blown soil that accompanies the wind. Abrasion of the soil on the leaves and desiccation of the leaves during and after the wind cause leaf burning. Wind damage also is sometimes attributed to static electricity, and wind without sand can burn margins and tips of wheat leaves. Lodging, or falling over of the wheat plant, is another form of wind injury. Lodging is most common after heading and when growth has been overstimulated by excess nitrogen fertilizer or moisture, high temperatures, or overplanting.

Preharvest sprouting of ripened grain occurs occasionally in eastern and central Kansas when harvest is delayed by wet conditions. Frequent rains, high humidity, and heavy dews cause kernels in the spike to absorb moisture and start germinating. Severe sprouting reduces the test weight and breadmaking quality of the grain. Fortunately, the Kansas climate, resistant varieties, and timely harvest make preharvest sprouting a rare problem.

Varieties

As wheat yields have increased, roughly half that increase has been due to improved varieties with the remaining half due to improved management. With environmental conditions so unpredictable and variable, proper variety selection can make the difference between profit and loss in many years, so it deserves careful attention each year. Obviously, the primary objective is to pick varieties that will give high per-acre yields and the highest possible net income, but this is not a simple matter.

Importance of Yield

Varieties do differ in grain yield potential. During the past 20 years, yields have increased approximately one-half bushel per acre per year, due to the release of new improved varieties. Consider choosing new released

varieties on a regular basis, perhaps every 3 to 4 years, to take advantage of the higher yield potential of new varieties.

High yield potential should not be the only yardstick for varietal selection and probably is not the most important criterion since many factors influence actual yield in the bin. Generally, for the top five or six recommended varieties, all will have very good yield potential. The key is to try to match the varieties' strengths and minimize weaknesses so a variety has the opportunity to yield well. Variety strengths (e.g. yield potential, pest resistance, or strong straw) should be matched against expected field problems (e.g. soilborne mosaic, Hessian fly infestation, or lodging). Since no perfect varieties have been developed, this usually results

in compromise and assumption of risks in order to gain advantages in other areas. Several different varieties should be planted in order to hedge against some of the unpredictable weather and pest problems.

The Numbers Problem

A complicating factor in recent years is the growing number of choices. It takes more time now to sift through characteristics, comparative performance data, seed sources, and relative prices than it did a few years ago. The Federal Plant Variety Protection Act stimulated private breeding and sales of variety seed by providing a plant patent protection to originators. Hybrids have their own built-in patent protection because new seed must be purchased for planting each year. In addition, Great Plains public breeding programs have been active in releasing new varieties in recent years.

Since it is not feasible for growers to individually test all varieties on their farm, they must rely on other sources for their information. Sources include their own neighborhood experience, county agent demonstrations and tours, Experiment Station field days and test information, seed company demonstrations, advertising, and meetings. It takes considerable effort, careful study, and good judgment to make intelligent choices from all of this information. Use your own experience with the varieties you have personally grown as a base for comparisons.

Kansas State University Experiment Station Help

The Experiment Station role has changed over the years. Varieties are not specifically recommended or endorsed by the experiment station. Instead, varieties are compared in scientifically conducted performance tests at 16 sites over Kansas each year, and the results are distributed to the public soon after harvest (Kansas Performance Tests with Winter Wheat Varieties). In addition, many greenhouse and laboratory tests contribute information on pest tolerance, baking quality, and other factors. Publications summarizing the above tests are available to growers at all county Extension offices. Several of the more important publications that are updated annually and available both in hard copy and electronically include: *Milling and Baking Qualities of Hard Winter Wheat Varieties*, which rates varieties based upon their end-use properties; *Kansas Performance Tests with Winter Wheat Varieties*, which includes detailed current-year data, summary yield data over 2, 3, and 4 years at all locations, public variety pedigrees, private company entries and addresses, and ratings for agronomic traits, disease and insect resistance, and bread-baking characteristics. *Wheat Variety Disease and Insect Ratings* provides the most recent ratings for new and established varieties and hybrids for resistance or

susceptibility to common insects and diseases attacking wheat in Kansas.

Excellent current information is also available from private publications. It is advisable to obtain as much information as possible before deciding on a variety to plant. Start with your production problems first; think about what problems reduced yield potential over the past 5 years, very likely there will be more than one. Try to identify varieties that have strong ratings for tolerance or resistance to these problems. From that list, consider where the varieties you have chosen are best adapted. Determine if the group of varieties has been tested for milling and baking quality and try to choose the varieties with above average ratings. Finally, from this group, pick the top 3 or 4 varieties based on yield in performance tests over a 2 to 3 year period. Avoid relying on data from few locations or only 1 year of testing. These data, no matter how reliable a specific test may be, can be extremely misleading.

Variety Complementation

Each variety as discussed above will have specific strengths and weaknesses, therefore it is recommended that 3 or 4 varieties be considered as the optimum for planting on the average wheat farm in Kansas. Because pest problems change and the growing environments are unpredictable it is dangerous to plant only 1 or 2 varieties. In choosing varieties consider the pedigree of the variety and how similar they are to each other. Planting both Karl and Karl 92 for example would give you little diversity in variety selection because they are very similar varieties. Choose varieties that have different pedigrees and different growing patterns.

Important Characteristics to Consider

Maturity

Early maturing varieties are more likely to escape damage from hot winds, drought, and rust. They are more subject to late spring freezes, however. Producers with a large number of acres can spread harvest by using varieties of differing maturity. Varieties or hybrids that flower earlier than Jagger or later than Arapahoe may run into production difficulties in Kansas from frost damage to heads and late-season hot winds, respectively.

Winter Hardiness

Wheat is most subject to damage from cold temperatures in the fall before wheat hardens and in the spring after growth starts. Varieties do differ in their susceptibility to freeze damage. Rating for winterhardiness are based on a scale of 1 (highest) to 9 (worst). Variety complementation is important for this trait. If you have decided to plant a variety that is rated average or poor for winterhardiness, you should select a complementary second variety with more emphasis on higher levels of winterhardiness.

Disease and Insect Resistance

Genetic resistance to insects and diseases is an excellent control method when such resistance is available. Hessian fly, wheat streak mosaic, soilborne mosaic, stem and leaf rusts, speckled leaf blotch, tan spot, and other diseases can and do cause serious losses in the Kansas wheat crop. Use of resistant or tolerant varieties, plus good cultural practices, can minimize losses.

Lodging and Shattering

Since wheat is harvested with the combine and harvesting must wait until the crop is ripe, varieties that do not lodge or shatter are desired. The shorter "semidwarf" wheats usually stand better than standard height varieties. Under dry conditions where deep planting is necessary, the short coleoptiles (sprouts) of some of the semidwarfs may cause a problem in obtaining good stands.

Grain Quality

The major use of Kansas wheat is bread wheat for human consumption. Therefore, it is important that the grain be of a quality needed by the millers and bakers to produce a quality end product. Quality is determined by variety as well as by growing conditions. Since quality is important, it is essential that producers consider quality in selecting varieties to grow.

Acid Tolerance

Many soils in Kansas are becoming more acidic due to the use of nitrogen fertilizers. Acidic (low pH) soils have more free aluminum, which can burn root tips and lead to poor vigor. As a wheat producer you should be aware of the pH of your soil. Wheat varieties do differ in their ability to tolerate low pH soils.

Coleoptile Length

Many newer semidwarf varieties have short coleoptiles that cannot emerge from deep planting. Rating for coleoptile length are based upon the standard check variety Larned. Producers should be attentive of seed planting depth if they are planting varieties with coleoptile lengths less than 3 inches.

Grazing Potential

Many Kansas wheat growers gain extra income by grazing livestock on wheat fields in the fall, winter or early spring. There are differences among varieties in the amount of forage produced. Producers should be careful in selecting wheat varieties for grazing without sound data. Although most current varieties are rated for their grazing potential, many newly released varieties have not been evaluated because the grazing or clipping tests are difficult and expensive. Awnless varieties can be grazed after heading in the spring because there is reduced danger of awns injuring livestock.

Planting Practices

Seed Quality

Utilizing good quality wheat seed for planting is the foundation for obtaining excellent germination and stand establishment. Good quality seed is true to variety, free of other crop seeds, weeds, foreign material, disease, and has plump, dense kernels of high germination. Seed quality is one of many factors that affects forage production and grain yield and can be very important when planting in poor conditions, such as dry soils, deep planting, or late planting. Growers may influence forage and grain yields with decisions relating to quality of seed that is to be planted.

Large, dense kernels are considered to be of better quality than low test weight kernels. Large seed tends to tiller more than small seed. However, small, dense kernels are better than large, light kernels. In the seed-cleaning process a gravity table will remove the light seed. After seed size, another factor related to seed quality is the protein content of the seed. The amount of protein, not protein percentage, in the seed is very important to early seedling vigor. Large seed may have a lower protein percentage than small, shriveled seed, but because it is larger it will have more total protein per

seed. Test weight of the grain is often used as a measure of seed quality, but test weight is a bulk density or a weight per volume measurement and small seed that packs well can have a high test weight. If producers use test weight as a seed quality measurement they should use seed with test weights above 57 pounds per bushel. Actually, a high thousand kernel weight (TKW) is a better measure of seed quality. A 30 gram TKW, which translates to 15,200 seeds per pound is an appropriate minimum TKW for a seedlot. There are a few varieties grown in Kansas that have small seed with a lower TKW, but their seed is still suitable for planting. With these varieties, producers should utilize the largest seed they can obtain.

Seed cleaning and sizing is essential to remove straw, chaff, dirt stones, weed seeds, and broken, diseased or small shriveled kernels. Generally, seed cleaning will add 1 to 2 pounds to the seedlot's test weight by removing the small kernels. Taking a germination test is essential to determine the seed viability. After seed germinability has been determined, the seeding rate can be determined. Seed to be used for planting should be above 85 percent germination.

Another reason for seed cleaning is the fact that semidwarf varieties tend to have more seed size variability. This has resulted in higher clean-out percentages. Although the clean-out fraction (small and shriveled kernels) contains seed that will germinate, this seed may germinate and emerge slower and less uniformly and produce weaker seedlings with fewer tillers than larger kernels.

Unfortunately, a few producers still use combine-run or bin-run grain as a seed source to be planted. Seed as received by a combine is seldom in condition for planting. Planting combine-run or bin-run seed allows a problem weed species to spread, since it is replanted with the uncleaned wheat seed.

Using certified seed is an excellent way to ensure the quality of a seedlot. All certified seed has been cleaned and is labeled according to seed law indicating variety, percent germination and date tested, percent pure seed, and percent inert material. The official minimum test weight for certified seed is 56 pounds per bushel. Certified seed is the grower's best assurance of purchasing excellent quality seed. Seed is a very low-cost item in the total production costs. High quality seed usually does not cost as much in the long run as bargain seed or low-priced seedlots. Poor quality seed can be expensive in terms of poor stand establishment resulting in yield losses and future problems with weeds and diseases.

Producers ask how often they should buy new seed. They are worried the varieties they are using will "revert back" or not remain pure. Wheat is a self-pollinated crop, so varieties remain true to type. But some cross-pollination or outcrossing can and does occur, especially when freezing or very cool temperatures occur at heading or flowering. When outcrossing occurs and that seed is used for planting, the subsequent plants may differ greatly in height and appearance from the original plants. Seed contamination with other varieties is another factor causing the wheat to look ragged with off-type plants. As most producers plant three or more varieties each year, they will purchase certified seed of one of their varieties each year. This will minimize the effect of outcrossing or contamination. With hybrid wheats becoming more prevalent producers will need to buy new seed each year. Planting saved seed of hybrid wheat will result in yield losses of 5 to 15 percent the following year.

Seeding Date

Climatic conditions vary greatly across Kansas causing the recommended planting dates to vary for different areas. Producers try to plant wheat at a time so seedlings have well established crown roots and three to five tillers before winter dormancy, thereby enabling the plants to minimize winterkill damage. Planting within a week of the Hessian fly-free date for an area will usually

allow enough time for adequate fall growth. Planting too early increases the hazards of insects and diseases, such as Hessian fly, leaf rust and wheat streak mosaic virus. But in areas where wheat is grazed, producers will plant 2 to 3 weeks earlier than they would if the wheat is to be used for grain to ensure fall growth for grazing.

In some areas of western Kansas, where available soil moisture is always a concern, planting too early can cause excessive fall growth and soil moisture depletion for early spring growth, but this is not a problem for much of the state. Planting later than optimum often causes limited fall growth, both root and tiller formation and subjects the wheat to wind damage and increased potential for winterkill damage. But producers may need to plant later when late rains allow grassy weeds, like cheat or downy brome to germinate and need to be destroyed by tillage. Also, in areas where wheat is double-cropped after row crops, wheat will be planted later than optimum.

Figure 1. Optimum planting dates in Kansas

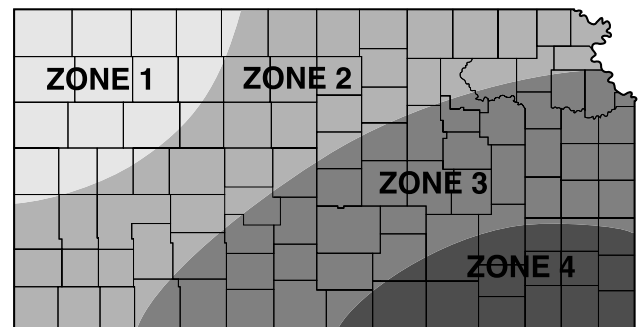

- Zone 1.....September 10-30
- Zone 2.....September 15-October 20
- Zone 3.....September 25-October 20
- Zone 4.....October 5-October 25

Seeding Rate

Seeding rates vary across Kansas like seeding dates because of environmental conditions. Due to the lower rainfall in western Kansas, generally, the seeding rates are lower than in central and eastern Kansas. But in western Kansas seeding rates have increased slightly during the past decade. Seeding rates in western Kansas range from 600,000 to 900,000 seeds per acre planted (40 to 60 pounds per acre at a rate of 15,000 seeds per pound). Considering 80 percent germination and emergence, the plant population may vary from 450,000 to 750,000 plants per acre.

With lower seeding rates the plants will tiller more than with higher seeding rates. A hard rain soon after planting may cause crusting and result in poor emergence and stands. Producers need to determine the plant populations before they decide to replant. In most areas,

stands can be reduced by 50 to 60 percent with only a small effect on grain yield. Producers may have areas within the field that require spot replanting to prevent wind erosion or weed problems.

In central Kansas, the seeding rates range from 750,000 to 900,000 seeds per acre (50 to 60 pounds per acre at a rate of 15,000 seeds per pound). Final stands should be 600,000 to 720,000 plants per acre. In eastern Kansas, the seeding rates range from 900,000 to 1,125,000 seeds per acre (60 to 75 pounds per acre at a rate of 15,000 seeds per pound) with final stands of 720,000 to 900,000 plants per acre. With irrigation, seeding rates may range from 900,000 to 1,350,000 seeds per acre (60 to 90 pounds per acre at a rate of 15,000 seeds per pound) and final stands of 720,000 to 1,080,000 plants per acre. Seeding rates can be adjusted upward by 10 to 20 percent if conditions are good or producers desire quicker ground cover. As planting date is delayed the seeding rate should be increased to compensate for the lack of tillering associated with delayed planting. With wheat double-cropping after row crops or planting wheat to graze, the seeding rate should be increased by 50 to 100 percent. Also, seeding rates should be increased 10 to 15 percent when using very large seed to compensate for fewer seeds per pound.

Wheat can emerge from various depths, but a planting depth of 1 to 2 inches is optimal. In drier areas, a hoe drill can place the seed deeper into moisture. With deeper plantings producers should be aware of the coleoptile length of the variety to be planted and should use varieties with long coleoptiles.

Figure 2. Optimum seeding rates by areas in Kansas

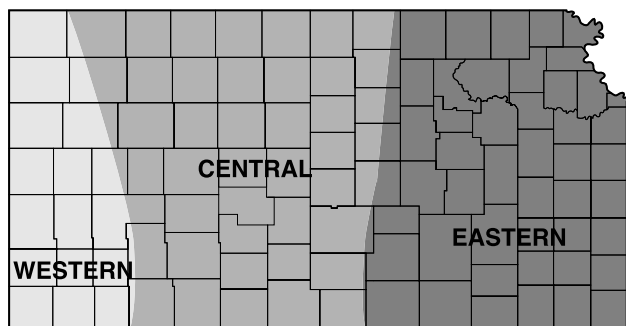

Western Kansas 600,000 to 900,000 seeds per acre
 Central Kansas 750,000 to 900,000 seeds per acre
 Eastern Kansas 900,000 to 1,125,000 seeds per acre
 Irrigation 900,000 to 1,350,000 seeds per acre

Seedbed Preparation

Seedbed preparation varies across the state depending on residue of the preceding crop, the need for moisture conservation, and the producer's attitude toward

tillage. The amount of tillage for seedbed preparation has been reduced during the past decade. Plowing, which was prevalent during the 1970s and 1980s is practiced only on a limited basis in the continuous wheat areas of south central Kansas. Producers should strive for a firm seedbed, which promotes good seed to soil contact and results in rapid germination and stand establishment, at the lowest possible cost. Frequently, producers will till in an attempt to cover all their acres when the soils are too wet for tillage equipment. This contributes to compaction and tillage pans which can cause problems later in the growing season.

In the continuous wheat areas of the state, residue management is difficult. Most producers use 1 or 2 diskings or a chisel operation to incorporate residues. This is followed by another disking or a field cultivator as planting time approaches. With more residues remaining on the soil surface, foliar diseases, such as tan spot and Septoria leaf blotch, have increased. Resistant varieties are important in this cropping system. On the heavier, sloping soils of eastern Kansas, soil erosion by water is a major concern. Terraces, waterways, and crop residue management are required on many highly erodible acres. Where crop rotations are utilized, the row crop residue after harvest is left untouched until late summer when 1 or 2 diskings or field cultivations are used before wheat seeding. Many producers have saved time and soil moisture by planting no-till wheat double-cropped after harvest. Most drills are able to no-till into soybean and sunflower residue in a wheat double-cropping situation. No-till drills are effective for planting into corn and sorghum residues. If the row crop is corn, some tillage may be performed to destroy the residue, which lowers the incidence of scab.

Traditionally, in western Kansas where moisture conservation is the most important goal, the wheat-fallow system has been dominant. In this system, a wheat crop is produced every 2 years. Summer fallowing allows soil moisture to buildup while the land is idle from one harvest through the next summer until wheat seeding in the fall. Unfortunately, the wheat-fallow system has a very low water-use efficiency. Tillage operations to control weeds cause soil moisture loss. As little as 0.25 inches of rain on bare soil can seal the soil and cause rain water to runoff. However, if residues are left on the soil by utilizing conservation tillage methods, soil moisture will be replenished sooner so that a summer crop (corn, grain sorghum, sunflower, or millet) can be planted to utilize the stored moisture. This wheat-summer crop-fallow system produces two crops in 3 years and has been shown to be more profitable than the wheat-fallow system.

Residues reduce evaporation, soil erosion, and runoff, and increase water infiltration and snow catch during the winter. After wheat harvest in the summer, a residual triazine herbicide replaces several tillage operations to

control summer weed growth. To maximize moisture savings, the wheat residue is left undisturbed until the summer crop is planted no-till into the stubble. After the summer crop harvest the residue is left untouched until the following fall when wheat can be planted no-till or if there is ample moisture in the soil profile in the spring producers may opt to plant a summer crop again.

Residue Management

Residue management, through conservation tillage, is an effective tool for reducing soil erosion. The percentage of the soil surface covered with residue is important in determining how much erosion will occur from rainfall runoff. Crop residue shields the soil surface from the rainfall impact, thus reducing the amount of particle detachment. Residue also reduces the amount of crusting, which allows more water to soak into the soil, and creates numerous small dams, which reduce runoff velocities and the capacity to carry sediment. Standing residue increases snow catch in the winter and increases moisture storage for the subsequent crop.

In Kansas, the highest erosive rainfall energies occur in late May and June when the growing wheat generally provides adequate cover to protect against soil erosion.

The potential for significant water erosion exists after harvest, because of the intense nature of thunderstorms typical of Kansas summers, and in the fall, when little residue may remain as a result of cultural practices.

Wind erosion is a serious problem in Kansas, particularly in late winter and early spring. Wind erosion is especially troublesome with wheat, because inadequate residue or growing cover exists during the critical period. Crop residue serves to reduce wind erosion by reducing the velocity of wind that contacts the soil surface by creating small, calm air pockets that allow airborne particles to fall back to the surface. Standing residue is more effective than flat residue in controlling wind erosion.

Research from neighboring states shows a 50 percent reduction in soil erosion on fields with 20 to 30 percent residue cover as compared to cleanly tilled fields. No-till planting reduced soil erosion by 90 to 95 percent. A 30 percent surface residue cover for water erosion control or 1,000 pounds of flat, small grain residue or its equivalent for wind erosion control after planting is usually adequate in Kansas. The actual level of residue required in your fields may vary above or below these limits. Local Natural Resources Conservation Service personnel can provide assistance in determining residue needs.

Nutrient Management

Adequate nutrients at each stage of development are essential for maximum economic yields of wheat. Nitrogen removal per bushel by wheat compared to corn and grain sorghum is slightly higher due to the higher protein content of wheat. Removal per bushel of other nutrients is very similar to corn and grain sorghum.

In general, nitrogen, phosphorus, and potassium are the primary nutrient needs. Most Kansas soils supply adequate amounts of the secondary and micronutrients. Climatic and cultural systems must be taken into account when developing a fertilization program.

Determining Nutrient Need

Nutrient need can be determined by several methods, including soil tests, field trials, nutrient removal, plant analysis, past experience, or a combination of these. Probably the most reliable means of determining lime and nutrient need is by soil testing regularly with support from the other methods listed. Remember a soil test is no better than the sample collected in the field.

Soil test interpretations are based on many years of research work conducted across the state and reliable interpretations can be made for the likelihood of obtaining a response provided yield potential is not restricted by other factors.

Lime

Liming should not be overlooked as wheat will respond to lime. Lime needs can be accurately determined by soil tests. The greatest need for lime is in the eastern two-thirds of Kansas. Very low pH soils have been found in south central Kansas and marked responses to lime application by wheat have been found.

Nitrogen

Nitrogen is the element most frequently lacking for optimum wheat production. Nitrogen recommendations are based on expected yield, cropping system, soil texture, and available profile nitrogen.

Table 1. Nutrient removal by wheat in the grain

Nutrient	Grain Removal lb/bu	Nutrient	Grain Removal oz/bu
Nitrogen, N	1.25	Copper, Cu	.012
Phosphate, P ₂ O ₅	0.48	Manganese, Mn	.036
Potash, K ₂ O	0.28	Zinc, Zn	.055
Sulfur, S	0.08		
Calcium, Ca	0.01		
Magnesium, Mg	0.16		

Adapted from "Our Land and Its Care," National Plant Food Institute

A soil test for available profile nitrogen is very helpful in evaluating the amount of residual nitrogen. The test measures the quantity of available nitrogen in the soil at the time the sample is collected. The soil sample for the available nitrogen test should be taken after July 1 for preplant and after November 1 for topdress applications.

The results from this profile test are interpreted for adjusting nitrogen recommendations to utilize accumulated available nitrogen found in the soil profile. Accumulations of available nitrogen are most likely to occur in fields receiving high nitrogen additions from either fertilizer or manure or having very poor yields because of drought, hail or other natural disasters. Accumulation of available nitrogen also may occur under summer fallow conditions because of the extended time for nitrification between crops. Because nitrates are mobile and move with soil moisture, sampling to a depth of 2 feet, when possible, is advised for this test and the interpretation of the test results is based on a 2-foot profile.

Another important consideration in determining the optimum nitrogen fertilizer rate is cropping sequence. Research in Kansas and adjoining states shows nitrogen credits for legumes grown in rotations can be substantial. Table 2 summarizes nitrogen credits for legumes. In contrast to row crops, no credit is given for wheat following soybeans because nitrogen needs for wheat come early in the spring before the nitrogen in the soybean residue is mineralized.

Table 2. Nitrogen credit for legumes in rotations with wheat

Previous Legumes		Nitrogen Credit lb/a
Alfalfa	> 80% stand	100-140
	60-80% stand	60-100
	< 60% stand	0-60
	Second year, 1/2 first year credit	
Red Clover		40-80
Sweet Clover		100-120
Soybeans		0

Nitrogen recommendations can be calculated by using these factors:

$$N \text{ Rec (lbs/a)} = [YG \times 1.75] \text{ STA} - \text{PCA} - \text{PYM} - \text{PNST}$$

where,

- N Rec = nitrogen recommended in pounds per acre
- YG = a realistic yield goal in bushels per acre
- STA = soil texture adjustment (1.1 for sandy soils and 1.0 for medium and fine textures)
- PCA = previous crop adjustment [use Table 2 for previous legumes, 20 lb for fallow (if no

profile N test) and 0 for all other previous crops.]

PYM = previous year's manure (50 lb for last year, 20 lb for 2 years ago and 0 for no manure history)

PNST = Profile nitrogen soil test results where, profile nitrogen is the sum of surface and subsoil nitrogen test results;

$$\text{Surface} = \text{__ppm N} \times .3 \times \text{__ depth, in} = \text{__ lbs/a}$$

$$\text{Subsoil} = \text{__ppm N} \times .3 \times \text{__ depth, in} = \text{__ lbs/a}$$

$$\text{Profile N} = \text{__ lbs/a}$$

Note: If no available nitrogen test run, then use default value of 30 for PNST.

Example:

Expected Yield - 40 bu/a
 Soil Texture - silt loam
 Previous Crop - sorghum
 Previous Manure - none

Soil test results

0 - 6" = 10 ppm NO₃-N
 6 - 24" = 8 ppm NO₃-N

$$N \text{ Rec} = (40 \text{ bu/a} \times 1.75 \text{ lbs/bu})1.0 - 0 - 0 - 61^* = 10 \text{ lbs/a}$$

$$^*(10 \text{ ppm} \times .3 \times 6" + 8 \text{ ppm} \times .3 \times 18")$$

Summer preplant and spring topdressing are the recommended times of nitrogen application for fall seeded small grains in Kansas. Preplant applications of nitrogen should be incorporated into the soil by tillage or injected directly into the soil. Applying nitrogen prior to seeding has several advantages among which are:

- eliminations of one planting time operation by incorporating fertilizer application into a tillage operation,
- deeper placement of the nitrogen to avoid poor utilization from dry surface soil conditions, and
- shifting the work load into a slack period.

Spring applications on the other hand have the advantage of better knowledge of moisture situation and crop condition prior to expenditure of money for nitrogen and a shorter period of capital tie-up prior to harvest. On sandy soils susceptible to leaching and on clayey soils subject to standing water, only a small amount of the total nitrogen should be applied in the fall. The rest of the nitrogen should be applied as a spring topdressing to minimize nitrogen loss through leaching or volatilization.

Nitrogen can be applied at seeding in small quantities for starter effect, but no more than 20 pounds of nitrogen plus potash (K₂O) per acre should be placed in direct contact with the seed. Germination injury is more severe in seasons of poor moisture.

Applying anhydrous ammonia with tillage implements is an excellent method of application. Applying nitrogen with undercutter blades and field cultivators is effective and thus offers an additional way to cut costs by combining tillage and fertilizer operations.

Spring applications of nitrogen should be completed by jointing, which normally occurs in early to mid-March. Later applications of nitrogen may increase protein content of the grain, but have less effect on yield. Spring applied nitrogen in general has increased grain protein content more than fall applied nitrogen.

Selection of a nitrogen fertilizer should be made on the basis of cost, availability, and ease of application. In calculating cost of specific materials, don't forget to include application costs. Research in Kansas has shown all nitrogen carriers to be essentially equal in supplying nitrogen for small grains when properly applied.

In years of heavy straw production, an additional 20 pounds of nitrogen per ton of incorporated straw should be considered to help decompose the straw, realizing additional residual nitrogen may be available for succeeding crops.

Fertilizing for Protein

In recent years, the average grain protein in Kansas wheat has been slightly over 11 percent, which is below the optimum for domestic flour production. This low protein content has been the result of several factors including a decline in available soil nitrogen.

Nitrogen fertilization for ensuring high protein in wheat requires nitrogen rates in excess of those for optimum grain production. Farmers undertaking a fertilization program for high protein must combine the practice with a marketing program to receive a protein premium to pay for the additional nitrogen. Additional nitrogen applied as a topdress above the recommended rate will favor higher protein. However, many climatic and genetic factors also are involved. Excess nitrogen applied early in the season can lead to lodging problems or excess nitrate leaching in some areas and should be approached with caution on fields with a history of lodging.

Phosphorus

Wheat is known to respond well to applications of phosphorus on soils testing low or very low in available phosphorus. Wheat plants do not tiller well under severe phosphorus deficiency and often are more subject to winterkill.

Phosphorus for small grains should be applied broadcast incorporated, injected in concentrated bands preplant, or banded at planting. Band applications of this plant nutrient with the seed at planting or injected preplant are recognized as being generally more efficient than

broadcast treatments, particularly when low rates are applied on acid soils low in available phosphorus. The efficiency of broadcast applications, regardless of soil pH and available soil phosphorus content, can be improved by incorporating the phosphorus fertilizer into the soil. This allows the plant to continue to use phosphorus even when the surface is dry.

Another alternative would be to band apply both nitrogen and phosphorus fertilizer before planting. Dual application of N and P with a tillage implement has the advantages of saving time by combining fertilization with tillage and of placing the phosphorus in the root zone for good utilization.

Liquids and solids as well as varying chemical forms of phosphorus (ortho- and poly-phosphates) are available on the market. Research conducted by Kansas State University researchers has shown that all are agronomically equal when applied at the same phosphate rate and by the same method of application. Selection of a phosphorus source, therefore, should be made on the basis of cost, availability and adaptability to your operations.

Potassium

Like for phosphorus, a soil test is your best guide to potassium need. Soils low in potassium are most likely to be found in southeastern Kansas or sandy soils in other areas of the state.

Potassium may either be applied as a planting time starter or broadcast and incorporated ahead of planting. These two methods should provide equal results. Applications of potassium in direct contact with the seed should be limited to avoid possible germination damage. If nitrogen also is to be placed with the seed, limit the total amount of nitrogen plus potash (K₂O) to 20 pounds per acre.

The most common potassium source is muriate of potash (potassium chloride); however, potassium sulfate, potassium nitrate, potassium-magnesium sulfate and mixed fertilizers are other sources of potassium. Little difference exists between materials in potassium availability. Selection should be based on cost, availability, and adaptability to the overall farm operation.

Other Nutrients

Sulfur deficiency may occur on sandy, low organic matter soils. Research has not shown a consistent response to sulfur on other soils, but with good yield potential, sulfur application test strips might be tried.

Yield increases to chloride application have been found with the most consistent increases coming in the

Table 3. Phosphorus recommendations for wheat

	Soil Test Level (ppm P)				
	Very Low 0-5	Low 6-12	Medium 13-25	High 26-50	Very High 51 or more
Nonirrigated	40-60	20-40	10-20	—	—
Irrigated	50-60	30-50	10-30	0-20	—

Table 4. Potassium recommendations for wheat

	Soil Test Level (ppm K)				
	Very Low 0-40	Low 41-80	Medium 81-120	High 121-160	Very High 161 or more
Nonirrigated	40-60	20-40	10-20	—	—
Irrigated	40-60	20-40	0-20	—	—

central and eastern parts of the state and under above average yield conditions with soil chloride levels in the top 2 feet of soil of less than 35 pounds per acre. Response to the chloride has been attributed to diseases suppression in some fields, but responses have been found where no visual disease symptoms were evident. Chloride rates of 15 to 30 pounds per acre of several chloride sources (potassium chloride, ammonium chloride and magnesium chloride) have been used. Preplant, planting time and topdress applications have all been effective.

There is little indication that nutrients other than those mentioned above are deficient for wheat in Kansas. Calcium and magnesium are relatively abundant in the majority of Kansas soils. Liming of acid soils supplies sufficient calcium and a deficiency of this element would not be expected.

Research with other elements such as boron, manganese, iron, copper and zinc has not revealed any consistent responses and these elements should not be a problem for optimum wheat yields.

Weed Management

Major Problems and Losses from Weeds in Wheat

Weeds reduce wheat yields and profits by competing with the crop for moisture, light, space, and nutrients. Weeds also interfere with harvest and result in dockage and lower quality grain, which adds to the total economic impact of weeds in wheat. According to a report by the Weed Science Society of America, weeds were estimated to cause over \$50 million annual loss in production of Kansas wheat.

Yield losses and harvest problems caused by weeds in wheat varies depending on the weed species, weed population, time of weed emergence, growing conditions, and status of the wheat crop. A healthy stand of winter wheat that has a head start on weeds is very competitive and will suppress weed growth and interference. However, a thin stand of wheat that is stressed due to disease, insects, nutrient deficiency, or drought is not very competitive with weeds. A few scattered large weeds may cause significant problems in some wheat fields, while a high population of small, late germinating weeds may have little impact in other wheat fields.

Time of weed emergence relative to crop emergence has a tremendous influence on competition and yield reduction caused by weeds. Weeds that emerge with the wheat crop or early in the season are more competitive with wheat than weeds that emerge later in the season. Thus, winter annual weeds generally cause more yield reductions in winter wheat than do summer annual weeds.

Winter annual weeds generally germinate and emerge in the fall about the time wheat is planted, and produce seed in the spring when wheat matures.

Germination depends on soil temperatures and precipitation. Winter annual weeds also may germinate and emerge during the winter or spring, but generally are not as competitive with the wheat as fall germinating weeds. Henbit, field pennycress, flixweed, mustards, jointed goatgrass, and cheatgrass (cheat, Japanese brome, and downy brome) are examples of important winter annual weeds that may infest winter wheat.

Winter annual broadleaf weeds such as flixweed, tansy mustard, field pennycress, and bushy wallflower are some of the most common weeds in winter wheat. They are prolific seed producers and may be present at high populations. Most winter annual broadleaf weeds can be easily controlled in wheat with herbicides, but can cause significant yield reductions if left uncontrolled. In

Figure 3. Wheat yield reductions as influenced by bushy wallflower competition and time of removal

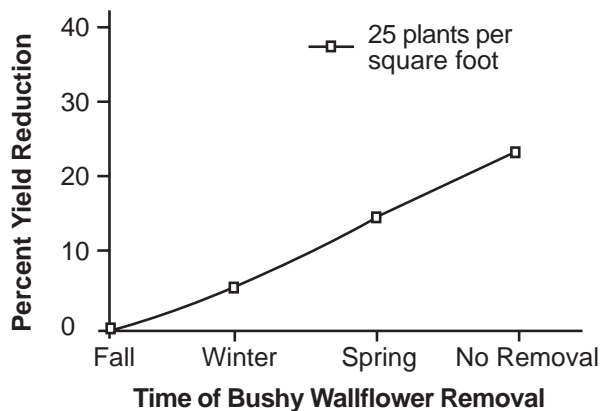

research at Manhattan, Kansas, a high population of bushy wallflower caused a 25 percent reduction in wheat yields from season long competition (Figure 3). Wheat yield reductions from bushy wallflower competition increased as treatment time was delayed. Timely weed control is important to minimize early season weed competition with the crop.

Winter annual grasses like cheatgrass and jointed goatgrass are some of the most troublesome weeds in wheat because of their competitiveness and difficulty to control. Research at the Hays Experiment Station found that 100 cheat or downy brome plants per square yard, that emerged within one week of wheat emergence, reduced wheat yields over 35 percent (Figure 4). Cheat and downy brome at 100 plants per square yard, that didn't emerge until 3 to 4 weeks after the wheat, only reduced wheat yields 12 and 6 percent, respectively. In addition, cheatgrass and jointed goatgrass also cause lodging, harvest difficulty, and dockage.

Figure 4. Cheat and downy brome competition with winter wheat as influenced by population and time of emergence

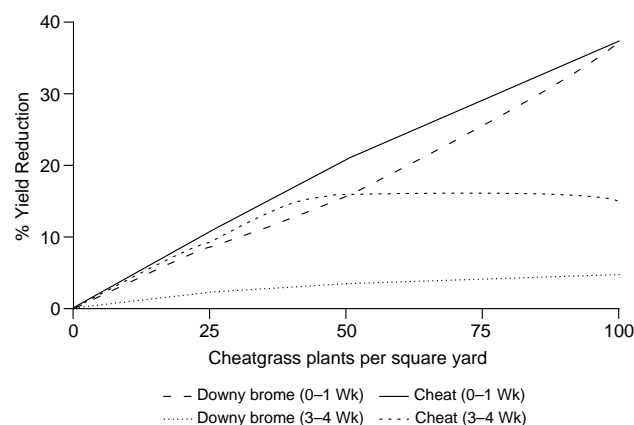

Summer annual weeds germinate in the spring and complete their life cycle during the summer months. Summer annual weeds often do not reduce wheat yields as much as winter annual weeds, but may interfere with harvest, especially in thin, stressed wheat stands. The summer annual weeds that usually cause the greatest problems in winter wheat are those that emerge early in spring, such as wild buckwheat, kochia, Russian thistle, and sunflower.

Perennial weeds generally are not as abundant as annual weeds, but are more difficult to control. Perennial weeds grow indefinitely over a period of years and reproduce and spread both vegetatively and by seeds. Many perennial weeds produce new stems from extensive root systems that can be spread from one area

to another. Therefore, the roots of perennial weeds must be killed or depleted of food reserves to achieve long-term control. Once established, perennial weeds are very competitive and difficult to control.

Field bindweed and woollyleaf bursage are examples of perennial weeds that may infest wheat. These weeds are fairly tolerant to the herbicides and rates that can be applied to the growing wheat crop, so the best time to manage perennial weeds is between crops or during a fallow period, especially in the fall. The most effective control programs generally consist of multiple treatments over several seasons. Established perennial weeds are rarely eliminated with a single operation.

Preventive Weed Control

Preventive weed management is prudent and economical. Introduction of new weeds into a clean field can increase weed control costs for many years. Weeds can be inadvertently introduced into clean fields with contaminated wheat seed, tillage and harvest equipment, manure applications, animals, wind, and water. Some of these factors cannot be controlled, while others can.

Plant only wheat seed that is free of weed seeds. Clean seed to be used for wheat planting, or purchase certified wheat seed that has been inspected and cleaned. Certified wheat seed cannot contain any prohibited noxious weed seed and must have the percentage of other weed seed contaminants listed on the label.

Clean equipment and combines when moving between infested fields. Field bindweed root segments can easily be transported within fields or between fields on field cultivators and other tillage implements. Combines are excellent at collecting weed seed and dispersing them at later times. Ask custom harvesters about previous jobs and inspect combines before entering fields. If possible, harvest the clean fields or parts of fields before harvesting weedy areas.

The only way to effectively control some potential weed problems is by hand removal when a few scattered weeds are first observed. Hand removal of a few scattered plants, such as volunteer rye, may be warranted to prevent having a more serious problem in future years.

Cultural Weed Control

Cultural practices can have a profound effect on weed problems. Production practices that encourage quick emergence and vigorous wheat growth will provide the crop with a competitive advantage over many weeds. Preparation of a firm seedbed, using high quality seed, fertility management, and proper seed placement can help establish a good healthy wheat crop.

The most serious weeds in a crop are those that resemble the crop and respond similarly to environmental and production practices. The winter annual grasses,

including cheatgrass, jointed goatgrass, and volunteer rye, are some of the more serious weed problems in winter wheat. Cultural practices are essential to manage winter annual grass problems.

Crop rotation is probably the best way to manage these weeds. Rotation to a summer crop helps break the life cycle of these weeds and allows the use of tillage or herbicides during the fall or spring to prevent seed production and deplete seed reserves in the soil. However, crop rotation without preventing weed seed production will not help reduce weed populations.

Burning and moldboard plowing wheat stubble have been shown to reduce populations of certain weeds, like cheatgrass, but may not be practical or acceptable due to the risk of soil erosion. The effectiveness of burning is variable and depends on the position of the cheatgrass seed, and the duration and temperature of the burn. Cheatgrass seed that is mixed down into the soil will not be very susceptible to burning, while cheatgrass seed that remains up off the soil surface is susceptible. Weeds with a hard seedcoat generally are not very susceptible to burning.

Plowing can reduce populations of certain weeds by burying the seed deeper than it can emerge. Plowing is fairly effective on cheatgrass problems because the seed is fairly short-lived, and cannot emerge from more than 3 to 4 inches deep in the soil. However, plowing may simply delay problems with other weeds, such as jointed goatgrass, because the seed goes dormant when buried deep in the soil. The seed remains dormant until brought back up to the soil surface with tillage in future years.

Planting date also can be manipulated to reduce populations of certain weeds. Winter annual weeds generally will start to germinate early in the fall, depending on soil temperatures and moisture. A delay in wheat planting date until several flushes of winter annual weeds have germinated and been destroyed with tillage or herbicides decreases the total number of weeds competing with the crop. However, delayed seeding may decrease grazing and yield potential depending on climatic conditions and planting complications.

Weed Control with Herbicides

Herbicides, if used properly, are a safe and effective option for control of certain weeds in wheat. However, herbicides will not solve all weed problems and should be used only as needed in an integrated weed management program. Several herbicides are approved for use on wheat to control different weed species. Important factors to consider when choosing a herbicide include: 1) weed species present, 2) stage of crop and weed development, 3) herbicide persistence and recropping restrictions, 4) and risk of off-site movement.

Knowledge of weed problems in the field and proper weed identification are necessary when choosing a herbicide. Most herbicides selectively control certain weed species as listed on the label. Weeds not listed on the label probably will not be controlled.

Herbicides should only be applied at the stages of application recommended on the label in order to achieve the desired results. Wheat must be in the proper stage of growth to avoid crop injury. Application too early or late may result in stunting and wheat yield reductions. Wheat generally is most tolerant to postemergence broadleaf control herbicides when the wheat is fully tillered, but prior to jointing. However, the proper wheat stage of growth for application depends on the specific herbicide. No herbicides are labelled for application when wheat is in the early boot to soft dough stage. Application during this time likely would result in sterility, poor grain fill, and reduced yields.

Postemergence herbicides generally are most effective when applied to small weeds that are actively growing. Winter annual broadleaf weeds are most susceptible when in the rosette stage of growth in the fall or early spring. Winter annual weeds that have bolted and produced the flowering stalk are more tolerant to herbicides and already may have caused some damage to the wheat.

Environmental conditions have a great influence on the activity of most herbicides. Preplant incorporated and preemergence herbicides generally need adequate precipitation following application to be effective. Dry weather following a preemergence application will not activate the herbicide and probably will result in poor weed control.

Most postemergence herbicides perform best with favorable temperatures and moisture for active growth of both wheat and weeds. Treatment with postemergence herbicides when the wheat and weeds are dormant generally is less effective, unless the herbicide also has residual activity in the soil, like Glean, Amber, or Finesse. Do not apply herbicides if the soil is frozen or covered with snow.

Always consult the label and follow directions concerning application rates, timing, spray additives, application technique, and personal protection equipment when using any pesticide. For more information on specific herbicide use and weed control ratings, refer to the annual KSU Report of Progress titled *Chemical Weed Control in Field Crops, Pastures, Rangeland, and Noncropland* available at your County Extension Office or the KSU Extension Distribution Center. The report of progress is revised annually and provides more specific information on herbicide use in wheat and other field crops.

Disease Management

Kansas wheat is subject to more than 30 different diseases. Estimated statewide losses due to all diseases combined are approximately 20 percent per year. Individual fields may sustain losses of 50 percent or more. In addition to yield loss, diseases frequently reduce the test weight. Two diseases, ergot and scab, may contaminate grain with mycotoxins. Therefore, diseases affect both the yield and quality of the wheat crop.

It is not possible to completely control all wheat diseases. Instead, concentrate on the most important diseases likely to affect each field. Your local K-State Research and Extension agent can help you determine which diseases are most important in your area. Then use a combination of disease management methods to minimize economic losses. Following are the main components of an integrated disease management program.

Scouting

Frequent field scouting is important for monitoring crop development and identifying problems in the early stages before they become severe. Correct diagnosis is crucial because control measures are different for the different diseases. Color pictures of common wheat diseases can be found in K-State Research and Extension publication S-84, *Diagnosing Wheat Production Problems in Kansas*. See your local county K-State Research and Extension agent for assistance in diagnosing wheat diseases.

Resistant Varieties

Resistant varieties are often the most effective, economical, and environmentally friendly method of disease control. Resistance ratings are published each year in K-State Research and Extension publication MF-991, *Wheat Variety Disease and Insect Ratings*. Resistance ratings are provided for wheat soilborne mosaic, wheat spindle streak mosaic, wheat streak mosaic, barley yellow dwarf, leaf rust, stem rust, Septoria leaf blotch, glume blotch, tan spot, powdery mildew, and Hessian fly. Resistance to the Russian wheat aphid and to the greenbug is available in some varieties. Some varieties, such as Karl 92, have partial resistance to scab. Some varieties also have moderate resistance to *Stagonospora nodorum* leaf blotch.

Planting several different varieties with different strengths and weaknesses is a good disease management strategy. It reduces the risk that any particular disease will cause catastrophic losses. Diversification of variety maturity also reduces risk of some diseases. The best example is scab, which attacks only when rainy weather coincides with flowering. Usually only certain varieties

are flowering when rain occurs, and the others escape infection. Finally, early varieties may mature before late season diseases like stem rust can become severe.

Crop Rotation

Crop rotation is a “best management practice” because it reduces the carryover of diseases, insects, and weeds between crops. It is very effective for controlling tan spot, dryland root rot, eyespot, *Cephalosporium* stripe, and take-all root rot. Crop rotation may reduce severity of scab, seedling blight, Septoria leaf blotch, *Stagonospora* leaf blotch, glume blotch, and sharp eyespot. One year of rotation or fallow is enough to break the cycle for most diseases.

A few pathogens can crossover between different crops. The take-all fungus can build up on barley, smooth brome, and weedy bromegrasses. The scab fungus builds up on corn and survives in surface corn residue. Therefore, avoid planting wheat after barley or brome, or into heavy corn residue.

Crop Residue Destruction

Crop residue destruction can reduce the risk of disease carryover following wheat, barley, brome, or corn crops. Tan spot, *Cephalosporium* stripe, scab, and take-all are diseases that may be reduced by crop residue destruction. Several tillage passes may be required to break up and bury most of the residue. This is expensive, loses soil moisture, and may lead to soil erosion.

Fortunately, residue destruction is not needed if planting into residue of soybeans, sorghum, alfalfa, rye, oats, or sunflowers. Year-old wheat residue also is safe.

In recent years, increased emphasis on erosion control and moisture conservation has made residue destruction undesirable for most producers. Luckily, increased freedom to rotate crops makes residue destruction unnecessary.

Volunteer Wheat Control

Volunteer wheat can be a “green bridge” that allows pests to survive the period between wheat crops. Volunteer wheat can serve as a reservoir for wheat streak mosaic, High Plains mosaic, barley yellow dwarf, leaf rust, stem rust, and take-all root rot. It also harbors Hessian fly, Russian wheat aphids, greenbugs, Banks grass mites, and wheat curl mites. Therefore, destruction of volunteer wheat is an important component of integrated pest management.

Since many of the pests on volunteer wheat are migratory, volunteer wheat should be eliminated at least 1/2 mile from wheat plantings. The objective is to break

the green bridge before the new crop emerges. Therefore, volunteer should be eradicated at least 2 weeks before planting to ensure a thorough kill. Sometimes a late flush of volunteer occurs around planting time. This late flush is not a risk factor if there was just previously a volunteer-free period to break the green bridge.

Volunteer can be destroyed with either tillage or herbicides. For further details, see Cooperative Extension Service publication MF-1004, *Be A Good Neighbor: Control Your Volunteer Wheat*.

Delayed Planting

Early planting is sometimes necessary for forage production or erosion control. However, early planting is also a risk factor for several diseases including wheat streak mosaic, High Plains mosaic, barley yellow dwarf, sharp eyespot, common root rot, and take-all root rot. Planting after the Hessian fly-free date reduces the risk of these diseases. Check your county K-State Research and Extension agent for your local fly-free dates.

Seed Treatments

Seed treatments are excellent for control of seedborne diseases such as common bunt and loose smut. In order to keep our seed supply clean, seed treatments are highly recommended for all seed production fields.

Seed treatments also can reduce seed rot and seedling blight. Although seedling blight is not common in Kansas, seed treatments may increase stands when planting in poor conditions or using seed of poor vigor.

Certain seed treatments give partial control of barley yellow dwarf, leaf rust, Septoria blotch, Stagonospora blotch, powdery mildew, take-all root rot, common root rot, or dryland foot rot. These seed treatments tend to be more expensive and may fit best in high yielding, intensively managed wheat fields. See your K-State Research and Extension agent for recent ratings of wheat seed treatments.

Certified Seed

Kansas certified seed has been inspected for common bunt, loose smut, and Karnal bunt. Using certified seed reduces the risk of introducing a seedborne disease into the field.

Foliar Fungicides

Foliar fungicides are one of the few disease management tools that can be used in the spring. Fungicides can control leaf rust, tan spot, Septoria leaf blotch, Stagonospora nodorum leaf blotch, and powdery mildew. Degree of control ranges from poor to excellent, depending on the particular disease, fungicide, application timing, and rate.

Frequently the yield increase from fungicides is not enough to pay for the pesticide application. Fungicides are most likely to be economical in seed production fields or high yield potential fields. See K-State Research and Extension publication MF-1026, *Wheat Foliar Fungicides* for further details.

Biocontrol

Biocontrol is the use of natural biological competition, predation, or antagonism to control a pest. Use of biocontrol to manage wheat diseases is currently limited.

Biocontrol of take-all root rot often occurs naturally in about the fourth or fifth year of continuous wheat culture. This biocontrol, called "take-all decline," keeps the disease in check so that losses are low. Unfortunately, crop rotation disrupts the biocontrol and losses can be severe when the field is again planted to wheat. Since take-all decline requires continuous wheat culture, its use is limited.

Some new seed treatments consist of living spores of biocontrol bacteria. It is likely that more biocontrol seed treatments will be available in the future.

Balanced Fertility

Maintaining balanced fertility may reduce some diseases. Chloride deficiency has been linked to greater susceptibility to foliar diseases. Excess nitrogen can promote the development of powdery mildew. Liming of highly acid soils often triggers the activity of take-all root rot in continuous wheat. More frequent liming to maintain a more constant optimum pH may lessen problems with take-all. Another strategy is to combine liming with crop rotation to break the take-all cycle.

Summary of Kansas wheat diseases

Disease	Pathogen	Symptoms	Importance	Conditions favoring disease	Control
Wheat soilborne mosaic	Wheat soilborne mosaic virus	Yellow areas in low parts of field appear in early spring, then fade. Leaves with mosaic of green spots on yellowish background; stunting.	Can cause severe losses in eastern and central Kansas; moving into center pivots in southwest. Resistance has greatly reduced losses.	High soil moisture during seedling emergence. Cool weather in spring.	Resistant varieties. Avoid overhead irrigation during emergence if using susceptible variety.
Wheat spindle streak mosaic (also called wheat yellow mosaic)	Wheat spindle streak mosaic virus	Yellow areas in low parts of field appear in very early spring, then fade. Leaves with mosaic of yellow spindle-shaped streaks on green background. Usually occurs with soilborne mosaic.	Occasional light losses in eastern and central Kansas; moving into center pivots in southwest. Not as serious as soilborne mosaic.	High soil moisture during seedling emergence. Cold weather in spring.	Resistant varieties (probably sufficient to avoid highly susceptible varieties). Avoid irrigation during emergence if using susceptible variety.
Wheat streak mosaic	Wheat streak mosaic virus	Yellow areas in field appear in spring; usually on field edges adjacent to volunteer wheat. Leaves with mosaic of yellow streaks, stripes, or mottling; stunting; prostrate tillers.	Can cause severe losses in western and central Kansas; rare in eastern Kansas.	Hail at harvest causes early volunteer. Wet summer favors volunteer. Early planting. Planting near volunteer wheat. Warm fall favors wheat curl mite vector.	Resistant varieties. Volunteer control. Delayed planting.
High Plains mosaic	Unknown; probably a virus	Yellow areas in field appear in spring; usually on field edges adjacent to volunteer wheat. Leaves with mosaic of yellow spots and streaks; stunting; eventually plant death. Usually occurs with wheat streak mosaic.	Seems to be much less common and less important than wheat streak mosaic. Disease also attacks corn.	Hail at harvest causes early volunteer. Wet summer favors volunteer. Early planting. Planting near volunteer wheat. Warm fall favors wheat curl mite vector.	Volunteer control. Delayed planting.

Disease	Pathogen	Symptoms	Importance	Conditions favoring disease	Control
Barley yellow dwarf	Barley yellow dwarf virus	Small or large patches of yellow plants noticed around boot stage. Leaf tip turns yellow or purple, but midrib remains green; stunting.	Occasional losses of 30%, mostly in eastern and central Kansas.	Early planting. High populations of aphid vectors in fall.	Resistant varieties. Delayed planting. Seed treatments.
American wheat striate mosaic	American wheat striate mosaic virus	Fine white, yellow, or brown striations on leaves; dark streaks on sheaths and glumes; stunting Randomly scattered in field	Rare disease. Can be confused with other diseases like black chaff or glume blotch.	High populations of painted leafhopper vector in fall.	None needed. Most varieties are highly resistant.
Bacterial leaf blight	<i>Pseudomonas syringae</i> pv. <i>syringae</i>	Water-soaked spots and blotches on leaves which soon bleach to white or gray; whole leaf may die.	Susceptible varieties may suffer severe losses.	Rain and high humidity at boot stage.	Most varieties are highly resistant.
Bacterial streak (also known as black chaff)	<i>Xanthomonas campestris</i> pv. <i>translucens</i>	Water-soaked, long streaks on leaves eventually turn brown; lesions sometimes covered with yellow droplets of exudate.	Common some years but losses are minor.	Rain and high humidity.	None needed.
Leaf rust	<i>Puccinia recondita</i> f. sp. <i>tritici</i>	Bright orange pustules on leaves.	Important most years, especially eastern and central Kansas.	Mild winter. Wet spring.	Resistant varieties. Foliar fungicides. Seed treatments. Volunteer control.
Stem rust	<i>Puccinia graminis</i> f.sp. <i>tritici</i>	Dark orange pustules on leaves, sheaths, and stems.	Susceptible varieties may occasionally suffer severe losses.	Mild winter. Warm, wet spring.	Resistant varieties. Early varieties may escape damage. Foliar fungicides. Volunteer control.
Stripe rust	<i>Puccinia striiformis</i>	Yellowish orange pustules arranged in stripes on leaves.	Rare and losses are minor.	Very cool, wet spring.	None needed. Some varieties are resistant.
Powdery mildew	<i>Blumeria graminis</i> f.sp. <i>tritici</i> (also called <i>Erysiphe graminis</i>)	Cottony white fungus on leaves, stems, and heads.	Susceptible varieties may occasionally suffer light to moderate losses.	High nitrogen fertilization. Cool temperatures. High humidity.	Resistant varieties. Avoid over-fertilizing with nitrogen. Foliar fungicides. Seed treatments.

Disease	Pathogen	Symptoms	Importance	Conditions favoring disease	Control
Tan spot	<i>Pyrenophora tritici-repentis</i>	Symptoms appear in late March or early April. Brown spots, often with yellow halo and darker center.	Important in continuous, minimum tillage wheat, especially in central and eastern Kansas.	Continuous, minimum tillage wheat. Wet spring.	Resistant varieties. Crop rotation. Wheat crop residue destruction. Foliar fungicides.
Septoria leaf blotch (also called speckled leaf blotch)	<i>Septoria tritici</i>	Brown to yellowish irregular shaped leaf blotches, usually with tiny dark black fungal bodies appearing as speckles in the leaf blotches.	May cause serious losses in some years, especially in central and eastern Kansas.	Wet spring.	Resistant varieties. Foliar fungicides. Seed treatments.
Stagonospora nodorum leaf blotch	<i>Stagonospora nodorum</i>	Brown, elliptical blotches on leaves and stems, sometimes with tiny light brown speckles in blotches.	May cause serious losses in some years.	Wet spring.	Resistant varieties. Foliar fungicides. Seed treatments.
Glume blotch	<i>Septoria tritici</i> and <i>Stagonospora nodorum</i>	Brown to light tan lesions on glumes and awns, sometimes with black or light brown speckles.	May cause serious losses in some years.	Rain after heading.	Resistant varieties. Foliar fungicides. Seed treatments.
Ergot	<i>Claviceps purpurea</i>	Kernels replaced by hard, purplish black fungal sclerotia with whitish gray interior and 1/4 to 1/2 inches long.	Rare, but potentially important because sclerotia contain mycotoxins.	Rain and high humidity during flowering. Proximity to grassy weeds.	Can be screened from grain if necessary.
Scab (also called Fusarium head blight)	<i>Fusarium graminearum</i> Group 2	Complete or partial white heads. Kernels are shriveled; chalky white or pinkish white.	Can cause severe losses in eastern and north-central Kansas; grain may contain mycotoxins.	Rain and high humidity during flowering. Corn stalks on soil surface.	Resistant varieties. Diversification of variety maturity. Crop rotation (except planting into corn residue).
Black point (also called black tip fungus)	various fungi	Embryo end of kernel is blackened; kernel may be shriveled.	Common when harvest is delayed; may result in lower grade grain or reduce germination.	Rain after wheat matures.	Prompt harvest.









Disease	Pathogen	Symptoms	Importance	Conditions favoring disease	Control
Seed rot & seedling blight	various fungi	Poor emergence. Discoloration of coleoptile, roots, or crown. Seedling death.	Occasionally a problem, especially with poor quality seed or planting in poor conditions.	Sowing seed with scab or black point symptoms. Planting very early or very late. Continuous wheat. High soil moisture after sowing.	Seed treatments. Planting at recommended time. Crop rotation.
Pink snow mold	<i>Microdochium nivale</i> (also called <i>Fusarium nivale</i>)	At green-up, leaves have large tan lesions with dark brown borders; leaves die and bleach white, sometimes with orange-pink tinge. Usually occurs in small patches	Rare and losses usually minor.	Long periods of snow cover.	None needed.
Common bunt	<i>Tilletia caries</i> or <i>Tilletia laevis</i>	Kernels replaced by fragile "bunt balls" which contain masses of fishy smelling dark powdery spores.	Occasionally a problem with bin-run seed.	Seedborne on exterior of seed. Seedling infection favored by cool temperatures during germination.	Seed treatments. Certified seed.
Karnal bunt	<i>Neovossia indica</i>	Kernels partially replaced by masses of fishy smelling dark spores.	Karnal bunt is not known to occur in Kansas, but could disrupt exports if found.	Seedborne on exterior and interior of seed. Seed infection favored by rain at flowering time.	Exclusion by quarantine. Certified seed. Seed treatments.
Loose smut	<i>Ustilago tritici</i>	Chaff and grain replaced by masses of black powdery spores; spores blow away, leaving bare rachis.	Occasionally a problem with bin-run seed.	Seedborne on interior of seed. Seed infection favored by rain at flowering time.	Seed treatments. Certified seed.
Cephalosporium stripe	<i>Hymenula cerealis</i> (also called <i>Cephalosporium gramineum</i>)	Broad yellow stripes running full length of leaf and leaf sheath. Stunting of individual tillers. White heads	Was common in 1980's; now very rare in Kansas.	Continuous wheat with minimum tillage. Acid soils. Freezing and thawing of soil.	Crop rotation. Wheat crop residue destruction. Delayed planting. Maintain pH above 5.5.

Disease	Pathogen	Symptoms	Importance	Conditions favoring disease	Control
Eyespot (also called strawbreaker)	<i>Tapesia yellundae</i> (also called <i>Pseudocercospora herpatrichoides</i>)	Brown lesions at base of stem; sometimes with charcoal gray fungal structures in center. Lodging.	Rare, but can cause severe lodging.	Continuous wheat. Cool, wet spring.	Crop rotation.
Sharp eyespot	<i>Rhizoctonia cerealis</i>	White heads, stunting. Tan lesion with brown border and sharply pointed ends at base of stem.	Common, but usually not severe; may also cause seedling blight.	Early planting. Continuous wheat.	Delayed planting. Crop rotation.
Take-all root rot	<i>Gaeumannomyces graminis</i> f.sp. <i>tritici</i>	White heads; stunting; shiny black discoloration of stem base; black, rotten roots. Usually in patches in the field.	Common in eastern and central Kansas and sometimes in center pivot fields in southwest. Can cause severe losses.	Continuous wheat with minimum tillage. Early planting. Planting wheat after barley or brome. Good soil moisture, especially in fall. Volunteer wheat. Liming soils.	Crop rotation (except barley and brome). Wheat crop residue destruction. Delayed planting. Volunteer control in continuous wheat. Seed treatments. Combine liming with crop rotation. Biocontrol.
Common root rot	<i>Cochiobolus sativus</i>	Brown lesions on subcrown internode; can lead to crown rot.	Common in early planted fields. Losses not well documented.	Early planting. Good soil moisture in fall.	Delayed planting.
Dryland foot rot (also called Fusarium crown rot)	<i>Fusarium graminearum</i> Group 1	White heads, pinkish brown stem base filled with white fungus; internal browning of crown tissue; stunting. Usually in drier part of field.	Occasional in dry years in southcentral and southwest.	Drought stress. Continuous wheat.	Moisture conservation practices. Crop rotation.
Crown rot	Usually initiated by cold injury; secondary invasion by various fungi	Crowns with internal browning; stands thinned; reduced tillering; poor vigor. Often worst on exposed hillsides, terrace tops.	Common throughout state after severe winter.	Drought stress. Loose soil. Cold tender varieties.	Use cold hardy varieties. Moisture conservation practices. Use soil packer if soil extremely loose after planting.

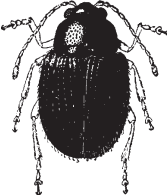



* Detailed fact sheets on some of these diseases are available at County Extension Offices and on the Worldwide Web at <http://www.ksu.edu/plantpath/extension/facts/>.



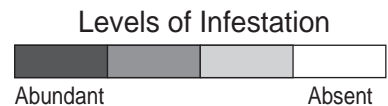





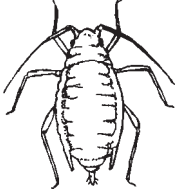
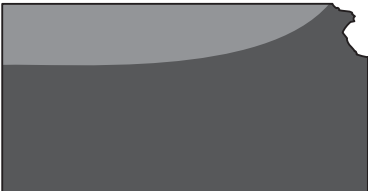
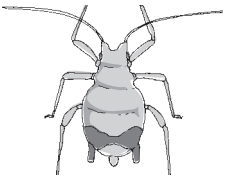
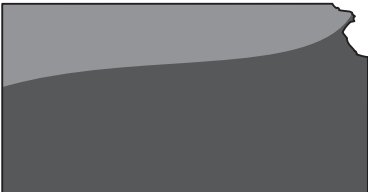
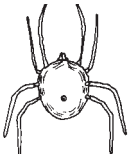
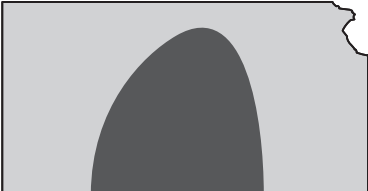

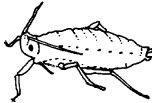
Insect Management

Part 1: Fall Problems - from planting to winter dormancy

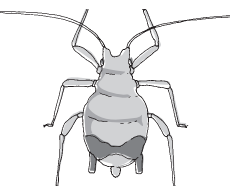
Pest	Where and When to Look	What to Look For	Action to Take
False Wireworm 	 Usually west of the Flint Hills, from prior to planting until after crop emergence.	Look for cylindrical yellow brown worms up to 1¾ inches long. After crop emergence, look for skips in the drill row. The larvae destroys the seed. Damage may be worse in dry soils.	Use seed treatment if worms are detected prior to planting in a dry seedbed. One worm per 3 square foot of row may be of economic concern.
Flea Beetle 	 Occurs statewide, but more common in the western areas in September and October.	Eats leaf surface in long, narrow streaks. Destroys the leaf surface on seedlings. More common along margins next to corn or sorghum.	Three to five beetles per square foot may justify treatment, depending upon seedling vigor, and stand density and extent of infested area.
Hessian Fly 	 In most areas of the state, main brood usually before fly-free date, but an additional brood possible.	Fall injury consists of stunted tillers often with an unusually large broad green leaf. Symptoms usually more prominent from mid-October into early November. Often worse in early fields.	Control is based on preventive measures taken prior to planting.
Grasshoppers 	 Often more severe in western areas of the state.	Look for chewing damage to plants around field margins and next to infested areas	Scout prior to planting, three to five grasshoppers per square yard should be controlled—if possible prior to planting.



Pest	Where and When to Look	What to Look For	Action to Take
Fall Armyworm 	 Attacks in the fall, watch early planted fields. Fall armyworms usually appear in September.	Watch for chewed for missing plants. Begins as small "windowpane" scars on leaf surface. As larvae get larger, they may chew plants into the ground.	Inspect daily in fields with 20 to 25 percent "windowpane" damage, Treat if signs of feeding continues to increase.
White Grub 	 Occurs statewide, sometimes more common in western areas of the state.	Look for the C-shaped grub larvae prior to planting. Grubs feed on roots and are usually located at 2 to 4 inches beneath the surface. After planting, look for pruned roots on stressed or dying plants.	Consider delaying the date of planting where early-fall grub counts average four to five or more per square foot in the upper 6-inch soil layer.
Greenbug 	 Statewide, but fall infestations in wheat are more likely to occur in the southern areas of the state.	Look for off-color spots in field. Leaves may have brownish spots, later leaves may turn yellow with light green soft bodied insects on underside of affected leaves. Infestations beneath the surface in loose soils are not uncommon.	Estimate number of greenbugs per foot of drill row. One way is place a white sheet of paper on the ground next to drill row and shake plants over the paper. Infestation is becoming serious when greenbugs average about 50 per foot on 3- to 6-inch plants.
Bird Cherry-oat Aphid 	 Can be found statewide, but like the greenbug, fall infestations are more common in southern areas.	Generally, plants look quite normal except for sticky leaves, and presence of small dark olive-greenish aphids on leaves, crowns or roots.	Feeding by this insect rarely results in serious plant damage, but it is most important as a vector of barley yellow dwarf. Disease prevention through aphid control has not been historically feasible.
Winter Grain Mite 	 Primarily during the fall in central and south central areas. More common in continuous wheat.	Irregular spots where leaves reflect a silverish cast. Scarring of tissue toward ends of leaves, brownish pinhead sized mites with red legs beneath plants on sunny days.	Spraying may be necessary on stunted, poorly tillered wheat if six to 10 mites per plant are common.

Pest	Where and When to Look	What to Look For	Action to Take
<p>Russian Wheat Aphid</p> 	 <p>Infestations are usually found west of Hays, and often more serious along the Colorado border.</p>	<p>Inspect leaves of individual plants on hands and knees. Signs of damage include rolled leaves and leaves with whitish, pink or purple streaks. Cigar shaped aphids present with the rolled leaves. Infestations often originate close to infested volunteer.</p>	<p>Consider treatment when 10 to 20 percent of the tillers show signs of infestation where the area of infestation occupies a significant portion of the field.</p>
<p>Greenbug</p> 	 <p>Early spring, statewide</p>	<p>Examine undersides of leaves of plants in several feet of row beginning shortly after greenup. Look for colonies of small green aphids.</p>	<p>Treatment is generally advisable when infestation levels reach 250 to 300 per row foot, where beneficial insects are relatively inactive.</p>
<p>Bird Cherry-oat Aphid</p> 	 <p>Seldom overwinters, may build up in late spring.</p>	<p>Dark colored aphids congregate in leaf axils. Usually, no apparent injury.</p>	<p>Control not generally recommended; however, at unusually high numbers (50+ per tiller) treatment might be worthwhile.</p>
<p>Hessian Fly</p> 		<p>The major spring symptom is stem breakage at a point just slightly above any of the joints. Consult publication MF-1076, <i>The Hessian Fly</i>.</p>	<p>A change in production practices is indicated in fields where infestations equal or exceed 10 percent or more of stems infested,</p>
<p>True Armyworm</p> 		<p>More common during wet periods in eastern Kansas. Black, green, and yellow striped worms strip the foliage, and beards.</p>	<p>Need for treatment is probable when present at levels of five to eight per foot before the flag leaf has been destroyed.</p>

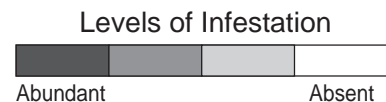

Irrigation Management

Kansas irrigated wheat acreage has remained relatively stable since an increase in the early 1980s to between 700,000 to 800,000 acres (Figure 5). Irrigated wheat production represents about one-fourth of the 3 million irrigated crop base and is the second most commonly irrigated crop in the state, following corn. Using average production figures for the past 5 years, just less than 7 percent of harvested wheat acres are irrigated and just over 10 percent of total production comes from irrigated land. Reported yield figures indicate irrigated land yields increases are 50 percent more than average dryland yield. The impact is even larger than this since most irrigated wheat production occurs in fallow wheat production areas. The majority of irrigated wheat production occurs in southwest Kansas.

Figure 5. Irrigated wheat acreage trends

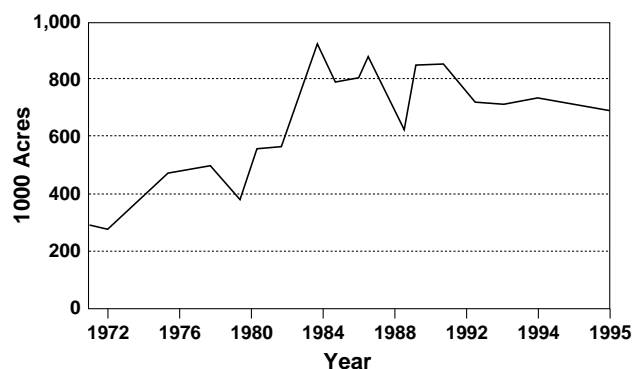

Water Use Characteristics

Wheat can develop an extension root system with penetration to 6 feet under favorable conditions. Most of this growth occurs in the spring during the rapid growth period after breaking of dormancy. A normal root extraction pattern is to have about 70 percent of water extraction occur in the upper one-half of the root zone. However, root extraction studies have shown wheat capable of extracting a substantial portion of its water need from the lower portion of the root zone. Soil water depletion levels can approach 80 percent of available water without serious yield potential reductions at most growth stages. However, the general recommendation would be to maintain soil water at above 50 percent depletion to maintain yield potential throughout the growth cycle.

All crops have characteristic water use curves. Summer grown crops have a bell shaped curve that indicates low daily water use needs in the spring, rises to a peak usually near the beginning of crop reproduction, then falls as the crop approaches maturity. Wheat has the same pattern, except that it begins its cycle in the fall and

is interrupted by a period of winter dormancy. Figure 6 illustrates the general shape of wheat's water use curve. After planting and emergence in the fall, water use increases as wheat establishes itself until temperature forces it into dormancy. Water use begins in the spring with rapid water use increase corresponding to the rapid period of growth between breaking from dormancy until heading. Boot to heading may be the critical stage of growth for wheat, although wheat is tolerant of water stress throughout its life cycles. Peak daily water use rates of wheat can approach 0.5 inches per day but normally peak use rates will be around 0.35 inches per day during heading and grain development. Water use rates drop off rapidly after grain development.

Figure 6. Characteristic water use of winter wheat

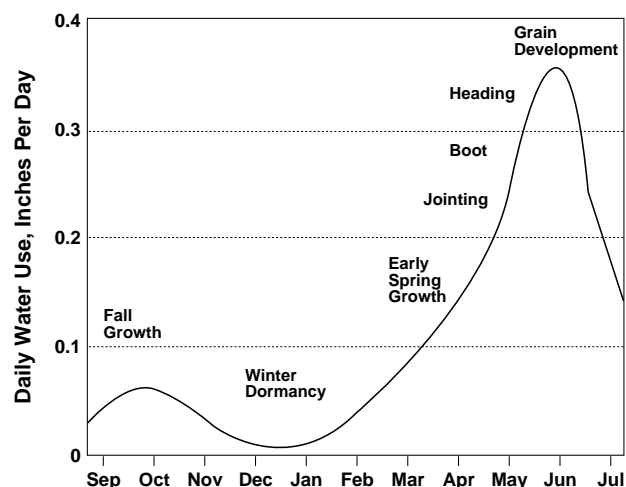

Total seasonal water needs of wheat will vary widely depending on weather conditions but are in the range of 16 to 24 inches for a wheat crop that is not water limited. Improvements in varieties and management practices have increased yields over time, but have not changed the water use requirements of wheat. A summary of Texas wheat research illustrates in Figure 7 that wheat water use (or ET) has stayed constant over the shown period of time which water use efficiency on the yield produced for each unit of water use doubled. The effects are similar in Kansas.

Cumulative water use for wheat is shown in Figure 8, based on an early research work at Garden City. As already indicated, even though varieties have changed yield potential, disease resistance, etc., the water use by wheat has not changed. About 20 percent of water use will occur from emergence to the beginning of spring growth, another 20 percent will be from spring growth to jointing, 10 percent jointing to boot, 12 percent boot to

Figure 7. Evapotranspiration and water use efficiency values for winter wheat at Bushland, Texas

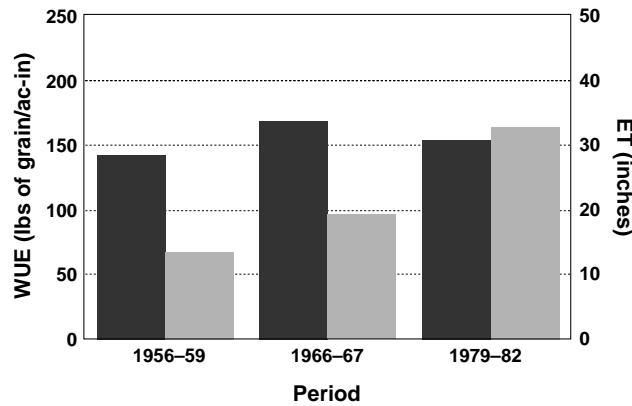

flower, 15 percent flower to milk, 8 percent milk through dough stage, and the remainder until complete maturity.

Net irrigation requirement as estimated in the Kansas NRCS Irrigation Guide for average rainfall range from about 12 inches in southwest Kansas to zero for eastern Kansas. Dry rainfall year estimates (80 percent chance rainfall) range from nearly 14 inches to about 3.5 inches across Kansas. The net irrigation requirement change across the state indicates why irrigated wheat production is concentrated in southwest Kansas. This is where the irrigation requirement is highest. Net irrigation requirement (NIR) for the 80 percent chance rainfall year are shown in Figure 9.

Irrigation Management

Much of Kansas' irrigated wheat production occurs on surface-irrigated deep silt loam soils, most often using a single fall irrigation application. The fall application amount is generally heavy, often in excess of 6 inches. However this normally results in yields at or above the good dryland fallow yields because of good stands and

Figure 8. Cumulative water use by irrigated winter wheat grown under adequate soil water for near maximum yields, KSU Garden City Branch Experiment Station 1957-1959

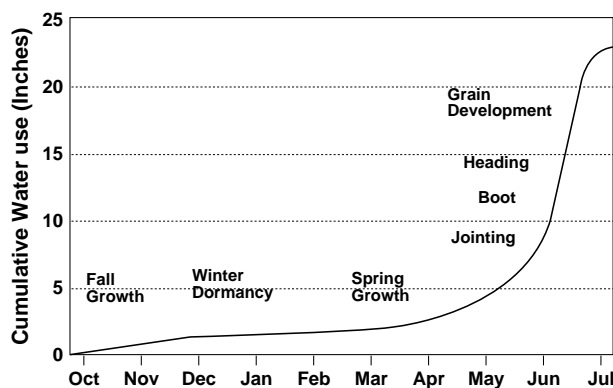
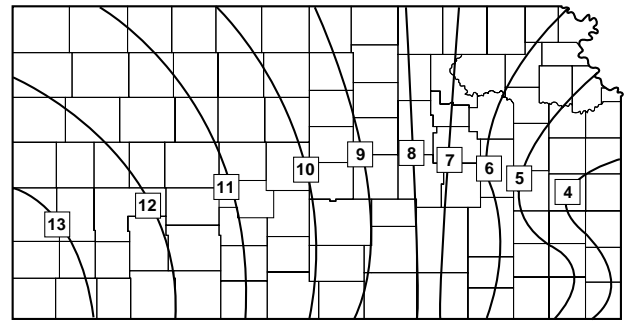

Figure 9. Net irrigation requirements for wheat, 80 percent chance rainfall



full soil profile after irrigation. Normally, surface distribution in the spring after rapid growth begins is not practical for surface systems. Wheat that is being irrigated with sprinkler systems can generally make better use of applied irrigation water since a small application depth can be efficiently applied in the fall to assure good stand establishment and the remaining water applied as needed during the spring growing season. This allows better storage and utilization of both dormant and growing season precipitation.

Soil water holding capacity has a large influence on which management strategies will be successful. Heavy fall irrigation works well on deep silt and silty clay loams with available water holding capacities of 2.0 inches per foot or more, but fall irrigation would be a failure on sandy soils with holding capacities around 1.0 inch per foot or less. Specific soils information can be obtained from county soil surveys, although general soils information and explanations can be obtained in KSU extension bulletin L-904 *Soil, Water, and Plant Relationships*.

Wheat irrigation is frequently used as a method of stretching the irrigation season since it has a growing season that is different from the other commonly irrigated but summer grown crops. Wheat also grows in a period when the potential demand for water is lower, and since wheat is relatively insensitive to water stress, long periods of time are available to irrigate wheat, utilizing low capacity wells, especially for individuals seeking to move to continuous production rather than a dryland fallow rotation.

Irrigation management strategies for full yield potential need to include scheduling of irrigation application to maintain soil water above 50 percent depletion. Stage of growth applications can be used to obtain maximum yield potential, but can be wasteful of water resources if water level status of soil profile is ignored.

A summary of wheat trials in Garden City, shown in Table 5, illustrates some of the different management concepts. Although yield potential is greater now than at the time of the study, as indicated by the previous discussion of Figure 7, the treatment effects today are similar. Fallow dryland yields are shown and indicate

Table 5. Effect of irrigation water management on wheat yields for different climatic years

Precipitation March 1-June 15* (Inches)	Grain Yield (bu/a)			
	Water Treatment			
	Fallow	Preplant Only	Preplant+ Boot	Preplant+ Scheduling based on Soil Water
2.67 (Dry)	3	33	46	48
4.94 (Below Normal)	26	44	48	48
8.90 (Above Normal)	8	51	51	53
11.78 (Wet)	33	51	50	50

* 50-year average March 1 - June 31 = 6.95 inches.

extremely variable yield, since the previous year's rainfall also would have a large impact of stored water availability in the soil profile, in addition to the in-season rainfall.

Preplant irrigation only is sufficient to obtain a wheat yield, even in dry years although at less than full yield potential. Preplant and boot irrigation yielded essentially at the same level as did irrigation treatments scheduled by observing soil water status. One problem associated with this study is duplicating the treatment effect in surface irrigated production fields. Essentially surface production fields can only apply a fall preplant or after emergence treatment and this and other studies indicate this will be a reliable production strategy, but in dry years some yield loss will occur.

Sprinkler systems generally will require 3 to 4 applications to duplicate the effect of the single heavy application amount. This, however, is an advantage since irrigations can be withheld if no water stress developed. In general, scheduling by soil water status or crop water use, will result in the highest yield potential with the lowest irrigation water input over the long-term since above normal rainfall years' water will be better utilized, thereby reducing irrigation demand.

Summary

Any amount of water applied to wheat under the normal growing conditions of western Kansas and in

most years in central Kansas will result in a yield increase. Successful wheat irrigation management is really a matter of understanding the irrigation system limitations and the soil water status. Most surface systems cannot efficiently apply water after spring growth occurs, so they are limited to fall water applications, which should achieve yields at or above good dryland fallow yields.

Irrigators using sprinkler systems should not apply heavy fall irrigations. Since sprinkler system operators have the option of applying additional irrigation at any time after the dormant season ends, the soil profile can be left with room to store winter and early spring precipitation. Wheat water use is low during this time because the crop is small and temperatures are cool. This means irrigation systems with limited capacity can build up soil water reserves, should an unusually dry winter occur. However, as wheat approaches jointing, soil water availability should not be allowed to deplete to less than 50 percent available throughout the remainder of the growing season. The estimated net irrigation requirement for wheat is about 15 inches in extreme southwest Kansas. If irrigation application amounts routinely exceed this level, the irrigator needs to consider whether improvements can be made in irrigation efficiency or if an improved irrigation water scheduling method can be employed.

Harvest Suggestions

Today's modern, high-capacity combines are designed to do an excellent job of threshing and cleaning wheat. All too often, however, part of the crop is left in the field or the quality of the grain harvested is less than desirable. Even in good harvesting conditions, combine losses as high as 10 bushels per acre of wheat can occur in Kansas. In most cases, a few minor adjustments can drastically reduce losses or improve grain quality. Since any additional wheat saved is clear profit and clean samples are not docked, a little extra attention to combine adjustment can pay off.

Preliminary Adjustments

As a general rule, start with the machine adjusted according to the specifications in the operator's manual. Engine speed is often taken for granted, but it is one of the most important adjustments of all. If the engine speed is too slow, separator speed will also be too low and performance will suffer.

Once the combine is adjusted and ready to harvest, be prepared to fine tune it as required. To fine-tune a combine, the functions of the machine and how they

relate must be considered. The combine's five basic functions are; cutting and feeding, threshing, separating, cleaning, and handling. The crop moves through the combine in this order. So if one function is not performing adequately, the areas that follow will have performance related problems. For example, if the header is too low and excess straw is entering the combine, threshing and separation will be difficult because of the excess material.

Cutting and feeding take place at the header and feeder house. Adjustments include header or cutting height, reel height and speed and reel position fore/aft. Cutting height is controlled by the operator as conditions change. The goal should be to harvest all grain with minimal chaff and straw. The reel should be adjusted to gently move wheat into the cutterbar by positioning it slightly ahead of the cutterbar. It should turn slightly faster than ground speed and be far enough down in the wheat to lay the heads onto the platform. Make sure the sickle is sharp and in good condition. A dull sickle can limit ground speed and cause shatter loss. Crop feeding from the header should be uniform to ensure proper threshing.

Threshing occurs at the cylinder or front portion of the rotor and is affected by concave clearance and cylinder/rotor speed. Cylinder/rotor speed determines how much grain damage will occur and the amount of seeds threshed from the head. Clearance will determine how many seeds are separated and drop through the concaves. Ideally threshing removes all grain from the head without damaging grain or straw.

Cylinder adjustment is also important since it affects the performance of the rest of the machine. First, verify that the cylinder clearance indicator on the machine is accurate. The bars and concaves may be worn such that the clearance is greater than shown by the pointer. The concave and cylinder must be parallel from side-to-side and the cylinder-concave clearance must have the correct convergence from front-to-rear. The operator's manual should include detailed instructions on checking and adjusting these items.

Underthreshing, or not completely removing grain from the head, makes separation difficult. It occurs when concave spacing is too wide or cylinder speed is too slow. Overthreshing is indicated by the straw being pulverized and broken up. As a result, part of the straw may overload the shoe, thus carrying grain over the back of the shoe. Other symptoms of overthreshing are cracked grain and excessive amounts of return. The cracked grain is more likely to be blown over the shoe, and even if retained in the grain tank, it causes problems in handling and storage. To avoid overthreshing, set the cylinder no faster and no tighter than absolutely necessary to thresh the grain from the heads. Some

operators prefer to leave an occasional kernel in the head as a sign of the best balance in threshing action.

Since threshing plays an important role in grain cleaning, the cleaning shoe should not be adjusted until satisfactory threshing occurs. Shoe losses can be caused by several factors in addition to overthreshing. Narrow chaffer openings can cause grain to be carried over, as can improper fan adjustment. If the chaffer is opened too wide, it will overload the sieve and increase tailings. Chaffer and shoe openings are measured perpendicular to the louvers.

An underblown condition at the shoe occurs when material is not adequately suspended in the air over the chaffer. This is caused by narrow openings or insufficient airflow. Grain should fall through the first two-thirds of the chaffer. If there is a thick mat of material on the shoe, grain cannot fall through and is carried over the rear of the shoe.

If chaffer openings are too narrow, grain through them is limited, increasing losses and limiting the overall capacity of the combine. Changing chaffer openings also affects air velocity and direction; therefore they should be adjusted together. Ideally chaffer airflow and movement suspends material over the chaffer and allows kernels to drop through to the sieve. Sieve openings should be set large enough to let all grain through without allowing foreign material into the grain bin. However if they are closed to keep foreign material out, returns should be monitored to ensure there is not too much grain being recycled.

Manufacturers have greatly improved the cleaning area on newer combines by developing new fans and precleaners. Many changes in machines have focused on achieving more uniform airflow across the cleaning shoe. These changes have improved the overall performance of the combine. Air type chaffers are popular as aftermarket equipment for combines. Some of these are adjustable and others are not, but most of them do a good job of removing large straw fragments.

Combine Capacity

Combine capacity is the maximum rate at which a properly adjusted combine can harvest a crop while maintaining an acceptable loss level. Capacity may be limited not only by cutting and feeding or power limitations, but also by the performance of any of the functional areas of threshing, separating, or cleaning. It is important to relate capacity to an acceptable overall loss level. A common limitation on conventional combines in wheat is straw walker overload. If the combine is pushed beyond a reasonable rate, walker overloading causes the losses to increase rapidly.

With constant crop conditions, feed rate will be proportional to ground speed. At low to moderate feed rates, much of the grain is actually separated in the concave area.

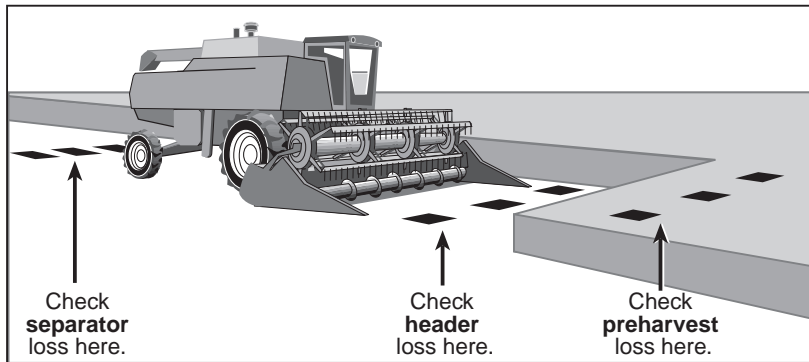

Figure 10. Measuring wheat harvest losses

About 90 percent of the separation should occur in the concave, leaving only 10 percent for straw walkers. At higher feed rates, the amount of separation in the concave area is drastically reduced so more grain is passed onto the walkers, resulting in excessive separating losses.

The only way to reduce walker losses is to **slow down**. Reducing ground speed by 25 percent on an overloaded combine can easily cut harvesting losses in half.

High Quality Wheat

Combine adjustment can affect wheat quality in two fundamental ways: grain damage and cleanliness. Grain damage consists of cracked and broken kernels that make wheat harder to handle, generate dust, harbor insects, and increase mold growth. Damaged grain also can be hidden in that the operator may not see it. Some damaged grain may end up in the bin, but a high portion will probably go out the back of the machine in the form of flour and small fragments. Generally 0.5 to 2 percent grain damage is achievable, but it can be much higher.

Grain damage occurs mainly in the threshing area of the combine, but also can be caused in the clean grain conveying system. In hard threshing wheat, there is a trade-off between thorough threshing and grain damage. An operator may not be able to completely thresh the crop without causing damage. Grain damage is usually caused by excessive cylinder/rotor speed. If slowing the cylinder/rotor speed doesn't improve the grain sample, adjustment of the concave clearance may be needed.

Foreign material also contributes to a lower quality wheat sample. Some weed seeds, especially cheat and downy brome, are difficult to separate from wheat. A good way to help is to harvest cheat infested fields last. Drier cheat is easier to clean and the yield in 'cleaner' fields is probably higher which makes them more important. Some general adjustments for cheat infested fields are:

- Chaffer toward open end of recommended range,
- sieve toward closed end of recommended range, and
- fan toward high end.

Following these guidelines will probably cause returns to increase, so keep an eye on machine capacity to avoid plugging.

Also watch your travel patterns when dealing with cheat. The combine is a serious vector for weed seed. It typically takes more than 1 minute to fully discharge cheat from a combine. If the combine is cutting cheat along the edge of a field, it can carry it 200 yards or farther into the field before it is through.

Estimating Your Losses

Checking the machine frequently is the best way to ensure efficient harvesting. During a single afternoon, conditions can change enough to require resetting some of the machine's components. A few simple ground counts will give an indication of combine performance. As a general rule, it takes about 20 kernels of wheat per square foot to equal one bushel per acre when spread evenly across the field. The only item needed to check losses is a one square foot frame made out of heavy wire to carry on the combine or in the grain truck. Follow these steps to determine losses:

1. Cut through a typical area at the usual speed, then stop the combine and back up about 20 feet.
2. In the area behind the separator discharge, lay the one foot square frame down three times and take ground counts (see Figure 10). Average the three counts. This is the separator count.
3. In the area between the cutterbar and the standing wheat, take three more ground counts and average them. Don't forget to look for heads. This is the header count.
4. Take a final three ground counts in the standing wheat and average them. This is the preharvest count.
5. Calculate header loss in bushels per acre.

$$\text{Header loss} = \frac{\text{Header count} - \text{Preharvest count}}{20}$$

6. Calculate the separator loss in bushels per acre.

$$\text{Separator loss} = \frac{\text{Separator count} - \text{Header count}}{80}$$

Since header width for most combines is about four times as wide as the separator, it takes about 80 kernels per square foot behind the separator discharge to equal 1

bushel per acre if no spreading devices are being used. If your combine has a bat type spreader, use 65 kernels per square foot instead of 80. If you have a straw chopper, use 50 and if you also have a chaff spreader, use 25.

What are acceptable losses? This depends on the condition of the crop as well as the attitude of the operator. However, for standing wheat under good harvesting conditions, machine losses can usually be held to 2 percent of the total yield. Higher losses will have to be tolerated in downed or damaged wheat.

Although simple to perform, the ground counts can be time consuming. It may be more practical to have the truck

or grain cart driver perform the separator ground count periodically during the day. This allows the combine to continue harvesting while the count is being made.

Correcting Your Losses

Since there are many factors that can create combine losses, an organized approach to correcting the problem is needed. Figure 11 shows one method for pinpointing the cause of the lost grain. When fine tuning a machine, try to change only one thing at a time so that the effects can be seen. Keep referring to the operator’s manual; it seldom pays to deviate very far from suggested settings.

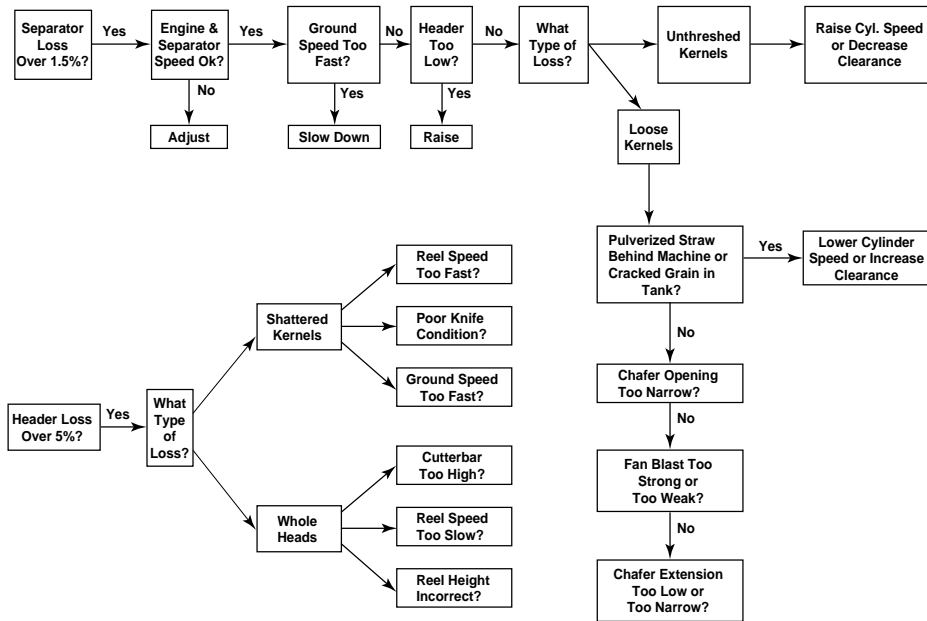

Figure 11. Correcting wheat harvest losses

Storage Management

Wheat stored on or off farm must be kept free of insects, fungi, rodents or other pests to ensure acceptance by domestic and foreign grain buyers. Low levels of insect infestations can develop into damaging populations before the grain reaches its final destination. Integrated pest management techniques during wheat storage require proper use of sanitation, chemicals, monitoring and aeration to maintain the wheat quality.

Potential Effect of Deteriorated Wheat

Many physical factors (moisture content, test weight, shrunken and broken kernel content, etc.) affect the market quality, and therefore, the price of wheat, but only a few are normally affected by deterioration during storage. The economic impact of deterioration depends on the type and severity of the damage.

Damaged Kernel (DKT) count may increase if molds are allowed to discolor the germs. Discounts may range from \$0.01 per bushel to \$0.15 per bushel or more depending on the percent DKT. The presence of live insects often causes the price to be discounted \$0.05 per bushel to \$0.10 per bushel. Uncontrolled mold or insect deterioration may result in objectionable odors or increase the number of Insect Damaged Kernels (IDK). This may cause the wheat to be designated sample grade with discounts of \$0.10 per bushel, or more, or rejection. IDK are a type of damage produced by lesser grain borers or weevils, and contribute to the DKT count as well as usually provoking a discount of \$0.03 per bushel or more, depending on the severity of the damage. Certain preferred buyers, such as flour mills, usually reject grain with live insects or more than 5 IDK per 100 grams.

Preventing discounts requires sanitation, monitoring, aeration, and proper use of chemicals.

DKT produced by mold is the simplest damage to prevent, since it is caused by excess moisture somewhere in the grain mass. Wheat should be stored at 13 percent or less moisture content. Insect control is the most difficult part of farm wheat storage since incoming wheat must be held through the summer before cool weather arrives. Discounts related to insect presences or IDK can be minimized using integrated pest management (IPM) techniques. Moisture migration and condensation can be prevented with proper aeration.

“What is the minimum insect density at which fumigation is cost-effective?” is a common question relative to insect control. The following guidelines are based on available field research and surveys. However, they are not applicable in every situation, and one’s local elevator or mill should be consulted to determine their insect thresholds. These guidelines assume that the wheat will be moved to market in the winter and that the objective is to keep insect levels below detectable levels.

- If more than two insects are found in samples, take a total of five samples from each bin.
- If lesser grain borers or weevils (internal feeders) are found in more than one sample, or if more than one of these insects is found in a single sample, fumigation may be necessary unless the entire grain mass can be cooled to below 50°F within 3 weeks.
- If only external-feeding insects (flat or rusty grain beetles, flour beetles, meal moths, sawtooth or merchant grain beetles, etc.) are found, an average of two per sample is usually acceptable if the grain can be cooled to below 50°F within 2 months.

Structures

The structure in which wheat is binned can help prevent loss and quality deterioration during storage. Structures used for grain storage should:

1. Hold the grain without loss from leaks or spills.
2. Prevent rain, snow, or soil moisture from reaching the grain.
3. Protect grain from rodents, birds, poultry, objectionable odors, and theft.
4. Provide safety from fire and wind damage.
5. Permit effective treatment to prevent or control insect infestation.
6. Provide headroom over the binned grain for sampling, inspecting, and ventilating.

A suitable storage for grain includes a weather-tight, rodent-proof, metal structure that is separated from hay and feed areas and animal housing. It should be easy to clean and inspect. It should have an aeration system that will allow you to cool the grain and thus limit insect development, and minimize moisture migration through the grain.

Insect Development

In Kansas, over 20 different species of insects are adapted to survive in grain or grain products. Common stored grain insects have a life cycle of 4 to 12 months. They may pass from egg to adult under optimal conditions in 30 days or less. Females of some common species can leave 300 or more eggs in the wheat within a few weeks. Not all insects cause damage and it is important to be able to recognize those that do, such as lesser grain borers or weevils.

Insect reproduction is directly related to temperature through the life requirement ranges. Optimal feeding and reproduction of most storage insects typically occurs from 70° to 90° F. Recent research has shown that optimum conditions for lesser grain borer are between 90° and 110° F for dry wheat. The lesser grain borer is the most damaging insect in Kansas farm stored wheat. As grain temperatures drop near 60° F, reproduction falls off rapidly. Most visible insect activity, including feeding, ceases when grain temperatures fall below 50°F.

Sanitation

Sanitation is critical to maintaining wheat quality while in storage. The optimum time to clean a bin is immediately after emptying and again 4 to 6 weeks prior to refilling. Critical areas where infestation can normally be found include the floor area and unloading pits or sumps. Other areas may include the bin walls, ladder rungs, and openings if debris (webbing, kernels, etc.) remains attached to them after unloading. Handling equipment should be used to remove debris and aeration ducts removed and cleaned. The area around a bin must also be kept free of debris, not only while the grain is in storage, but also while the bin is empty.

Nearby grain or feed storage bins, feed processing centers or livestock feeders can provide breeding sites for insects. Insects also harbor over the winter inside combines, trucks, or handling equipment. Harvesting and handling equipment need to be cleaned following harvest and then scoured as soon as harvest begins. New grain “scours out” the machinery and removes a potential source of infestation. This “scoured” wheat should be fed to livestock rather than sold to prevent infesting other wheat.

When it is binned, newly harvested grain will most likely be at optimum temperature and moisture conditions for insect development. Breeding areas in the immediate storage area are an important source of insects that may invade newly stored grain. Unless steps are taken to prevent this crossover infestation, several generations of insects could develop before cold weather impacts the insects’ reproduction cycle.

New grain should not be stored on top of grain that has been in storage. If the old grain has even a low-level infestation, the problem will spread upward into the most recently added grain. Extensive “hidden” damage may

result before the infestation reaches the surface layer where problems are more readily detected. A precautionary fumigation of old wheat should be undertaken if new wheat has to be stored on top of existing wheat.

Bin Wall Treatments

Bin wall treatments help eliminate insects remaining in the cleaned structure. Structural sprays are used 4 to 6 weeks before grain enters storage. *After cleaning the structure thoroughly*, walls, roof, and floor should be sprayed as directed on the label. Posttreatment waiting intervals before binning the grain should be in accordance to product label. If more than 3 months elapse from treatment to filling of the bin, a second bin-wall treatment may be useful. A second treatment must be permitted by the product label and applied accordingly.

Malathion, Methoxychlor®, and Reldan® treatments are registered for wheat storage structures. Malathion cannot be used if soybeans are the next crop to be stored in the structure. Cyfluthrin (marketed as Tempo®) recently has been labeled as an empty structure spray. Like Methoxychlor®, Tempo® cannot be applied directly to any grains. Refer to product labels for information on application rates and procedures.

Protectants

Grain protectants are insecticides designed to be placed on the grain kernels entering storage. Grain protectants retain their insect-toxic properties for an extended time period, depending on the grain moisture content and temperature. They are not highly volatile and penetration into infested kernels is very limited. Protectants do not destroy eggs and internally feeding insects since fatal amounts of insecticide are probably not absorbed by these forms after application.

Malathion and chlorpyrifos-methyl are the major ingredients labeled for direct wheat application as a grain “protectant” at this writing. Of these two products, the active ingredient in Reldan® (chlorpyrifos-methyl) has demonstrated longer lasting residual control in several research trials, especially where wheat with higher than recommended moisture contents has been treated. Chlorpyrifos-methyl also is more widely recognized as effective against Indian meal moth larvae than currently labeled rates of malathion. Some export and domestic customers are now purchasing only wheat without chemical residue.

Some types of inert dusts (diatomaceous earth, etc.) are available for use as protectants against grain storage insects. Inert dusts may increase grain-handling machinery wear due to their abrasive characteristics. There also has been some indication that test weights may change following the application of an inert dust to some grains. Inert dusts must carry specific label mention of stored grains to be used this way in Kansas. Limited data from field scale trials is available at this writing.

Surface Treatments

Split applications may perform more consistently when applying surface dressings. Labels may recommend to divide the product into two or three lots. Apply the lots to the grain surface based on the label recommendations. Most protectants cannot be used as surface dressings if they have been used applied as a protectant during binning since the maximum residue tolerance may be exceeded.

Slow-release DDVP or dichlorvos strips and several formulations of *Bacillus thuringiensis*, a biological insecticide, are available for use against Indian meal moth adults and larvae, respectively. The strips are hung in the overspace at the rate of 1 strip per 1,000 cubic feet and release a volatile insecticide that permeates the air. In contrast, *Bacillus thuringiensis*, is mixed with the surface 4 to 6 inches of grain and kills young Indian meal moth larvae that feed on the treated grain.

Fumigants

Fumigants rapidly form penetrating gases when released from the container used to transport them. These gases readily move into infested kernels and should eliminate all insect life stages if applied properly. Fumigants do not provide residual protection so reinfestation can occur immediately after the grain has been “aired out” and gas concentrations fall below lethal levels. Field studies in Kansas found October to be the optimum time to fumigate farm-stored wheat, if treatment became necessary. Covering the surface with plastic was required for effective fumigation. Fumigants are restricted use products. Fumigation requires specialized training and well-maintained application, monitoring, and safety equipment. It can be fatal to the user if recommended label procedures are not closely followed. Data from research in Kansas in 1991 showed that 35 percent of Kansas farmers who fumigated some wheat used a commercial applicator. Unless a producer is willing to invest the time and money necessary to acquire the equipment and knowledge needed, fumigation should be left to reputable professionals.

Aeration

The purpose of aeration is to cool the wheat. This reduces an insect’s ability to reproduce in it and minimizes temperature gradients. Aeration cools grain by forcing ambient air through the wheat with fans. Grain is cooled using aeration or drying fans. Aeration fans move less than $\frac{1}{3}$ cubic foot of air per minute per bushel (cfm/bu) through the storage structure. Approximately 80 to 120 hours are required to cool the grain depending on the airflow rate. The difference between the grain temperature and outdoor air temperature should be a minimum of 10°F before an aeration fan is turned on. At harvest, when temperatures are above 90°F, a 20°F differential should be used before operating the fans.

Drying fans move 1/2 to 1 cfm/bu through the grain and require less than 24 hours to cool a bin. Temperature differences of 15°F between grain and air are recommended when aerating with a drying fan.

Simple or complex automated aeration controllers are available. Controllers automatically turn a fan on based on preset weather and grain conditions. Automatically controlled aeration fans will cool grain 6 to 8 weeks earlier when compared to manually controlled aeration fans. Automated aeration controllers can be effective in cooling grain in storage earlier, thus minimizing the crossover impact, by running aeration fans only when the outdoor temperatures are below a preset temperature.

Stored grain contains moisture that can be transferred within a bin primarily in response to temperature differences. Differences develop either when the surface or perimeter areas around the bin cool or heat due to outdoor air conditions or because of insect or mold activity. Moisture transfer can result in damp areas within a mass of grain that are favorable for mold development. Temperature differences can be controlled with aeration.

Moving the air up through the grain is generally recommended and requires exhaust vents or roof openings. After the grain has been cooled, the aeration fan needs to be covered if the fan is not automated with a controller. This prevents rodents from entering beneath the grain and reduces the potential for air currents transferring moisture within the grain. The wheat should be clean and level on top to assure uniform air movement throughout the mass. Aeration is ineffective in cooling wheat located in peaks. Peaking wheat also creates breeding grounds for insects and molds and presents special problems when fumigating.

Monitoring

Best management practices require monthly inspection throughout the storage period. Risk of major deterioration can effectively be eliminated by frequent monitoring. Monitoring requires a grain probe, moisture meter, temperature measuring device, and screening pans. Changes in moisture content, insect activity, odor, or temperature can best be detected by inspections. An inspection log or diary should be maintained for future reference.

Monitoring is more than simply scooping grain from the surface, especially if it has been cooled. Insects may concentrate near the top of the grain and give a false impression of the infestation level. Warm weather infestations generally are near the grain surface or areas below the points of entry. A monthly approach to sampling is to sieve several samples probed from each bin.

Pest Control Decisions

The results of sampling will tell you if sanitation and management were successful in controlling insects.

There are three basic management strategies for storing wheat. These do not begin to include all possible combinations of management strategies using protectants, fumigation and aeration. All begin with proper sanitation and require frequent monitoring.

A maximum input/low risk strategy costs between \$.025 to \$.03 per bushel (assuming no fumigation is needed) and involves:

1. Applying a protectant at binning,
2. Summer aeration to equalize moisture and temperature differences,
3. Fumigating prior to November 1 if necessary, and
4. Aerating in late fall to cool wheat below 50°F.

Studies indicate Reldan® is generally more effective than malathion. If the protectant is properly applied and recommended sanitation and monitoring practices are followed, no fumigation may be required. A chemical residue does remain on the wheat when using this strategy.

Another practice is a fumigation/aeration strategy which involves:

1. Applying no protectant at binning,
2. Scheduled or routine fumigation in the early fall,
3. Continuous aeration in early fall to cool wheat below 75°F, and
4. Aeration in late fall to cool wheat below 45°F.

Cost for a fumigation-aeration strategy ranges from \$0.015 to \$0.035 per bushel. Proper aeration is critical during the late summer and prior to first fumigation to avoid having to re-fumigate. Temperature range guidelines provided by the fumigant manufacturer should be followed to obtain the most effective fumigation.

More recent field studies indicate that an automatically controlled aeration strategy can be an effective practice and involves:

1. Cooling wheat below 75°F by late August,
2. Cooling wheat by late September to 60°F,
3. Fumigation, if necessary, in early fall and
4. Continuing to cool the wheat below 45°F.

The wheat cools gradually or in intermittent periods since the fan runs only when the outdoor air temperature and/or humidity is below the controller set point.

Automatically controlled aeration costs range from \$0.005 to \$0.01 per bushel with the controller's initial cost between \$300 and \$2,500, depending on complexity. This strategy can be managed manually, avoids the problem of chemical residue, and has a lower cost. This strategy has been field tested on farms in Kansas and performed well.

Because of economic, environmental, and food safety concerns, chemical treatment of grain should be minimal unless insect thresholds are exceeded or long-term storage is desired.

Profit Prospects

Kansas has long been known as the “bread basket” of the world because of its ability to produce high- quality wheat. Kansas consistently ranks number one or two in the production of wheat, with 18.7 and 13.1 percent of the total U.S. wheat crop in 1994 and 1995, respectively.

The total acres of wheat harvested in Kansas remained fairly stable during the period 1993-95 at about 11.17 million acres or about 52.5 percent of the state’s harvested crop acres. In 1995, 11.0 million acres of wheat were harvested. Approximately 286.0 million bushels of wheat were produced for an average yield of 26.0 bushels per harvested acre.

Each producer must answer two questions when selecting crops and the acreage of each crop to produce are: (1) Will this choice be profitable? (2) Will this add more to the total net income of my farm operation than other choices? That is, is this the most profitable choice?

The fixed or overhead costs of land and machinery ownership for wheat, soybeans, corn, and grain sorghum will be basically equal for the production period under consideration. Therefore, the variable costs associated with each crop are the costs that need to be considered when selecting a given crop. Variable costs include: labor, seed, herbicide, insecticide, fertilizer, fuel, oil, repairs, crop insurance, drying, custom work, crop consulting, and miscellaneous.

Variable costs will vary depending on the management practices used, tillage operations, labor efficiency, and type and fertility of the land. Each producer should develop the variable costs of production for wheat and any other crop alternatives. Expected yield and selling price need to be determined for each crop alternative.

Budgeted variable costs by item are shown for dryland wheat production in western, south central, north central, northeast, and southeast Kansas, and for irrigated wheat production. A producer may have higher or lower costs than presented in these budgets.

The prices used in these tables are **not** price forecasts. They are used to indicate the method of computing expected returns above variable costs. These projections should be considered valid only under the costs, production levels and prices specified. Individuals or groups using the information provided should substitute costs, production levels, and prices valid for the locality, management level to be adopted, marketing circumstances for the location, and time period involved.

The decision to plant wheat or another crop alternative can be made by comparing the expected returns above variable costs for each crop. Returns above variable costs will depend on yields and prices. Each producer should use yields that are reasonable for the land or classes of land operated.

The decision to produce wheat will depend primarily on the costs and expected returns for wheat in comparison with other crop alternatives. However, the producer should take into account other variables such as previous crop rotation, livestock operation, and the machinery and labor requirements of each crop.

The type and amount of equipment, crop rotations, and farm size all affect the cost of producing crops. The tillage practices used and their timing, also affect yields and production costs. Each producer should compute the expected returns above variable costs for the farm operation as a means of selecting the crops and acreage of each crop to produce. When computing expected returns above variable costs, consider a number of price alternatives.

Estimated Variable Costs of Production

	Southeast	Northeast	South Central	North Central	Western	*Irrigated	My Farm
Wheat	\$ 91	\$ 86	\$ 78	\$ 82	\$ 77	\$135	_____
Soybeans	98	111	99	98	—	162	_____
Corn	155	172	151	162	115	321	_____
Grain Sorghum	109	119	88	110	85	183	_____

*For each crop, the values represent an average of the variable costs for flood and center pivot irrigation practices.

Expected Returns Above Variable Costs for Wheat

	Southeast	Northeast	South Central	North Central	Western	*Irrigated	My Farm
Yield per acre	35	35	35	35	40	65	
Returns:							
Yield per acre x \$4.15	\$145.25	\$145.25	\$145.25	\$145.25	\$166.00	\$269.75	_____
Government Payments	8.61	10.64	14.98	13.18	13.96	13.96	_____
TOTAL RETURNS	\$153.86	\$155.89	\$160.23	\$158.43	\$179.96	\$283.71	_____
Variable Costs:							
Labor	16.65	16.65	15.30	15.75	9.90	18.00	_____
Seed	16.00	18.00	12.00	12.00	10.00	18.00	_____
Herbicide	4.41	4.41	8.49	8.49	14.82	4.41	_____
Insecticide	0.00	0.00	0.00	0.00	0.00	0.00	_____
Fertilizer-Lime	25.00	17.75	14.90	15.65	15.20	22.45	_____
Fuel and Oil-Crop	6.20	7.12	6.00	8.39	6.95	9.54	_____
Fuel and Oil-Pumping	0.00	0.00	0.00	0.00	0.00	26.51	_____
Machinery Repairs	13.50	12.85	12.50	13.22	11.02	14.56	_____
Irrigation Repairs	0.00	0.00	0.00	0.00	0.00	2.70	_____
Crop Insurance	0.00	0.00	0.00	0.00	0.00	0.00	_____
Drying	0.00	0.00	0.00	0.00	0.00	0.00	_____
Custom Hire	0.00	0.00	0.00	0.00	0.00	0.00	_____
Crop Consulting	0.00	0.00	0.00	0.00	0.00	5.25	_____
Miscellaneous	5.25	5.25	5.00	5.00	5.00	7.00	_____
Interest on 1/2							
Variable Costs (10%)	4.35	4.10	3.71	3.93	3.65	6.42	_____
TOTAL VARIABLE COSTS	\$ 91.36	\$ 86.13	\$ 77.90	\$ 82.43	\$ 76.55	\$134.84	_____
EXPECTED RETURNS ABOVE VARIABLE COSTS	\$ 62.50	\$ 69.76	\$ 82.33	\$ 76.00	\$103.41	\$148.87	_____

*The irrigated wheat budget represents an average of the variable costs for flood and center pivot irrigation practices. Fuel-oil and irrigation repair costs will vary slightly between flood and center pivot irrigation.

Southeast Kansas

	Yield	Price	Net Gov't Payments	Gross/ Acre	Variable Costs	Return above Variable Costs	Fixed Costs*	Return above All Costs
Wheat	35	\$4.15	\$ 8.61	\$154	\$ 91	\$ 63	\$ 75	\$(12)
Soybeans	25	6.95	8.61	182	98	84	75	9
Corn	85	2.95	8.61	259	155	104	75	29
Grain Sorghum	75	2.80	8.61	219	109	110	75	35

*Based on \$625 per acre land at 6 percent; \$3.13 per acre taxes. Depreciation, interest, and insurance on \$255 per acre machinery investment equals \$34.

Northeast Kansas

	Yield	Price	Net Gov't Payments	Gross/ Acre	Variable Costs	Return above Variable Costs	Fixed Costs*	Return above All Costs
Wheat	35	\$4.15	\$10.64	\$156	\$ 86	\$ 70	\$ 84	\$(14)
Soybeans	35	6.95	10.64	254	111	143	84	59
Corn	100	2.95	10.64	306	172	134	84	50
Grain Sorghum	75	2.80	10.64	221	119	102	84	18

*Based on \$775 per acre land at 6 percent; \$3.88 per acre taxes. Depreciation, interest, and insurance on \$255 per acre machinery investment equals \$34.

South Central Kansas

	Yield	Price	Net Gov't Payments	Gross/Acre	Variable Costs	Return above Variable Costs	Fixed Costs*	Return above All Costs
Wheat	35	\$4.15	\$14.98	\$160	\$ 78	\$ 82	\$76	\$ 6
Soybeans	32	6.95	14.98	237	99	138	76	62
Corn	85	2.95	14.98	266	151	115	76	39
Grain Sorghum	60	2.80	14.98	183	88	95	76	19

*Based on \$675 per acre land at 6 percent; \$3.38 per acre taxes. Depreciation, interest, and insurance on \$240 per acre machinery investment equals \$32.

North Central Kansas

	Yield	Price	Net Gov't Payments	Gross/Acre	Variable Costs	Return above Variable Costs	Fixed Costs*	Return above All Costs
Wheat	35	\$4.15	\$13.18	\$158	\$ 82	\$ 76	\$ 77	\$(1)
Soybeans	28	6.95	13.18	208	98	110	77	33
Corn	80	2.95	13.18	249	162	87	77	10
Grain Sorghum	70	2.80	13.18	209	110	99	77	22

*Based on \$675 per acre land at 6 percent; \$3.38 per acre taxes. Depreciation, interest, and insurance on \$245 per acre machinery investment equals \$33.

Western Kansas

	Yield	Price	Net Gov't Payments	Gross/Acre	Variable Costs	Return above Variable Costs	Fixed Costs	Return above All Costs
Wheat	40	\$4.15	\$13.96	\$180	\$77	\$103	\$77	\$26
Corn	75	2.95	13.96	235	115	120	77*	43
Grain Sorghum	60	2.80	13.96	182	85	97	77	20

*Based on 1.5 acres of land for each acre harvested. \$525 per acre land at 6 percent; \$3.94 per acre taxes. Depreciation, interest, and insurance on \$190 per acre machinery investment equals \$26.

Irrigated Crops

	Yield	Price	Net Gov't Payments	Gross/Acre	Variable Costs	Return above Variable Costs	Fixed Costs	Return above All Costs
Wheat	65	\$4.15	\$13.96	\$284	\$135	\$149	\$142	\$ 7
Soybeans	50	6.95	13.96	361	162	199	142*	57
Corn	190	2.95	13.96	574	321	253	142	111
Grain Sorghum	110	2.80	13.96	322	183	139	142	(3)

*Represents an average of flood and center pivot irrigation practices, and was based on \$870 per acre land at 6 percent; \$4.35 per acre taxes. Depreciation, interest, and insurance on \$715 machinery and irrigation equipment investment equals \$85. Center pivot irrigation would have depreciation, interest, and insurance expenses of \$116 on a machinery and irrigation equipment investment of \$930. Flood irrigation would have depreciation, interest, and insurance expenses of \$56 on a machinery and irrigation equipment investment of \$505.

My Farm

	Yield	Price	Net Gov't Payments	Gross/Acre	Variable Costs	Return above Variable Costs	Fixed Costs	Return above All Costs
Wheat	_____	_____	_____	_____	_____	_____	_____	_____
Soybeans	_____	_____	_____	_____	_____	_____	_____	_____
Corn	_____	_____	_____	_____	_____	_____	_____	_____
Grain Sorghum	_____	_____	_____	_____	_____	_____	_____	_____

Brand names appearing in this publication are for product identification purposes only. No endorsement is intended, nor is criticism implied of similar products not mentioned.

Publications from Kansas State University are available on the World Wide Web at: <http://www.oznet.ksu.edu>

Contents of this publication may be freely reproduced for educational purposes. All other rights reserved. In each case, credit authors, *Wheat Production Handbook*, Kansas State University, May 1997.

Kansas State University Agricultural Experiment Station and Cooperative Extension Service

C-529

May 1997

It is the policy of Kansas State University Agricultural Experiment Station and Cooperative Extension Service that all persons shall have equal opportunity and access to its educational programs, services, activities, and materials without regard to race, color, religion, national origin, sex, age or disability. Kansas State University is an equal opportunity organization. Issued in furtherance of Cooperative Extension Work, Acts of May 8 and June 30, 1914, as amended. Kansas State University, County Extension Councils, Extension Districts, and United States Department of Agriculture Cooperating, Marc A. Johnson, Director.

File code: Crops and Soils 1-1